

FENCEPRO®



GATEPRO®

**ABBHEY**  
HARDWARE®

# PRODUCT CATALOG

GATE HARDWARE, FASTENERS AND SUPPLIES

---

FENCING SUPPLY EXPERTS





# What Makes Us Different...

Abbey Hardware is the sole wholesaler in the United States for GATEPRO® & FENCEPRO® Brands of quality and innovative gate, fence and shed hardware. As a leader in the gate hardware industry in the USA for over 2 decades there are many things that set us apart.

- Massive Selection of in stock Wood & Vinyl Gate Hardware
- Complete Line of Construction Supplies & Tools for the Fencing Industry
- Huge selection of Screws & Nails for the Fencing Industry
- Great Hardware Products for Sheds and Barns
- Exclusive Product Range (designs you won't find anywhere else)
- Free Shipping with Low Minimums
- Hinges Available in a Broad Size Range up to 48"
- An Uncompromising Commitment to Value and Quality
- Unparalleled Customer Service & knowledge of the industry



**We guarantee  
the performance  
and quality of  
every one of our  
products.**

**Customer Service: 1-866-982-2239**

**FENCING SUPPLY EXPERTS**





# Table of Contents

● Standard Gate Components	01	● Shed & Barn Hardware	57
● Gate Frames	13	● Post Support Products	63
● Traditional Hardware	15	● Fieldgate Fittings	65
● Polymer & Vinyl Gate Hardware	25	● Nails & Staples	69
● Aluminium Gate Hardware	31	● Screws & Fasteners	75
● Antique Ironmongery	33	● Tools	85
● Aluminium Privacy Panels	38	● Construction Supplies	101
● 316 Stainless Steel	39	● Fence Stain	109
● Security Products	43	● AG Fencing / Welded Wire	113

# Guide to Our Quality Finishes

## Standard & Vinyl Hardware Black Finish

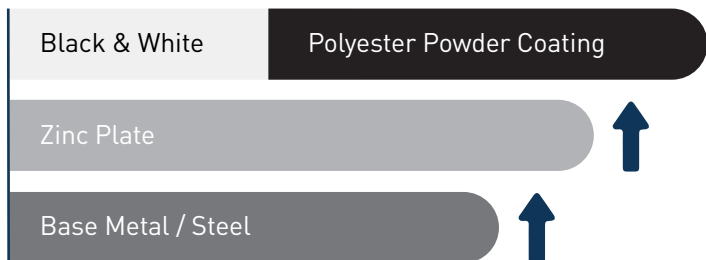

## Premium Shell

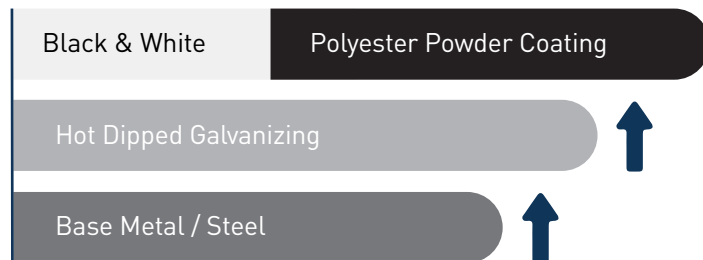

## Zinc (E-Galvanizing)



## Marine Grade 316 Stainless Steel

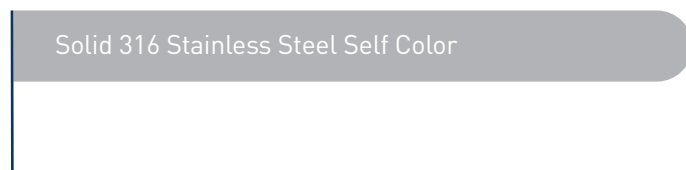

## Hot Dipped Galvanizing

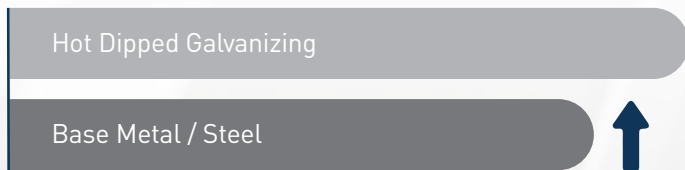

## Stainless Steel

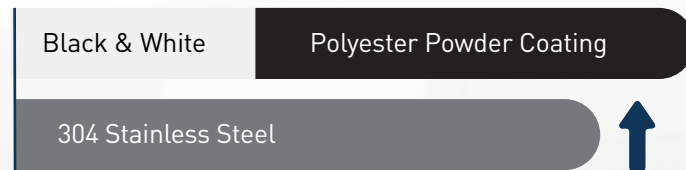



# STANDARD GATE COMPONENTS

This section includes a full range of quality, everyday, wood gate hardware. Most standard products are available in zinc plated, hot dipped galvanized, and powder coated black finishes.

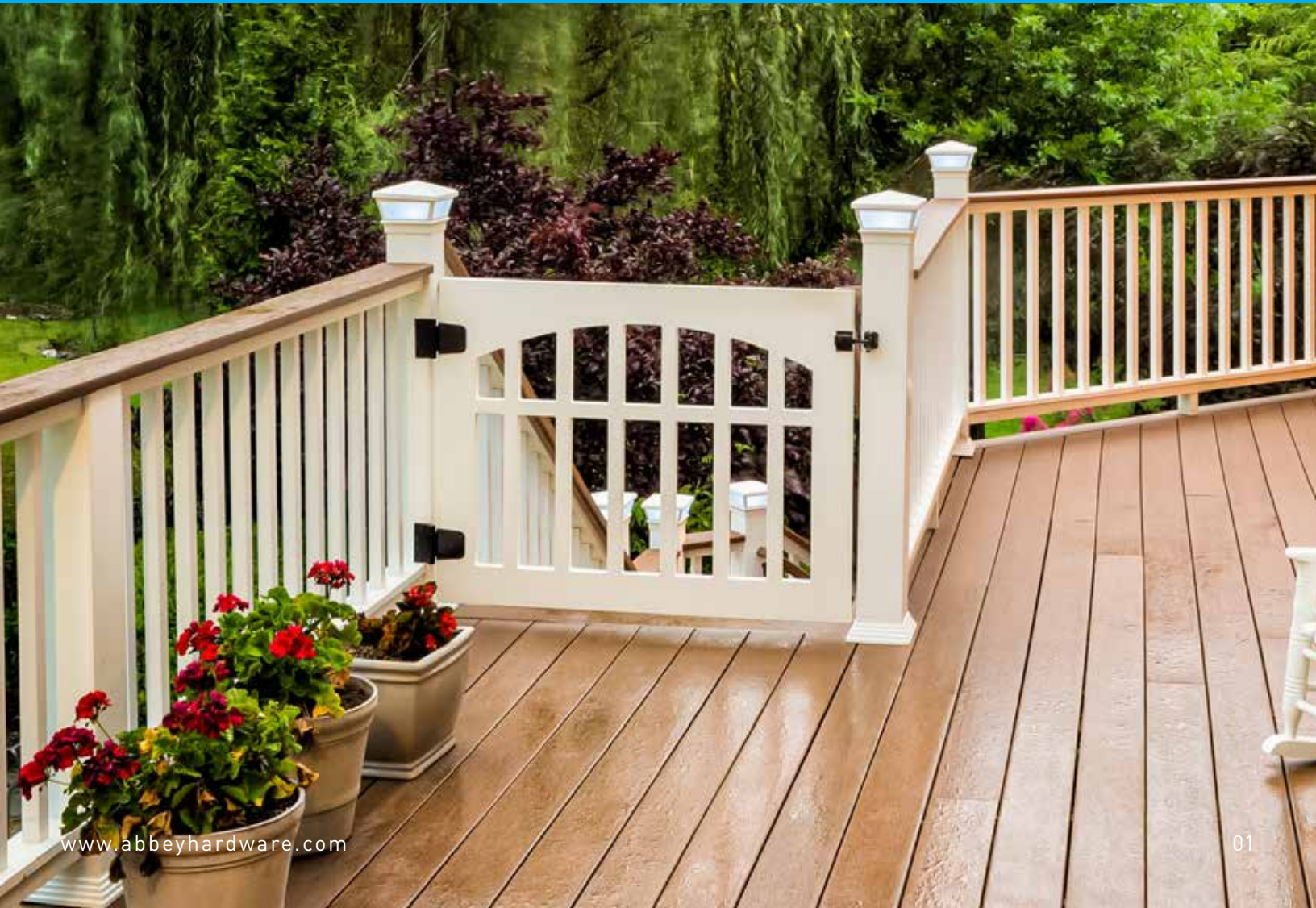

# STANDARD GATE COMPONENTS

## HINGES



PRE-PACKED

### STANDARD TEE HINGES

SIZE INS (MM)	FINISH	QTY PER BOX	CODE	PRE-PACKED CODE
3" (75)	Galvanized	10/100	004 075 1	
3" (75)	Zinc	10/100	004 075 2	
3" (75)	Black	10/100	004 075 3	
4" (100)	Galvanized	10/100	004 100 1	
4" (100)	Zinc	10/100	004 100 2	
4" (100)	Black	10/100 (5/50 PP)	004 100 3	050 100 3
6" (150)	Galvanized	10/60	004 150 1	
6" (150)	Zinc	10/60 (5/30 PP)	004 150 2	050 150 2
6" (150)	Black	10/60 (5/30 PP)	004 150 3	050 150 3
8" (200)	Galvanized	10/30	004 200 1	
8" (200)	Zinc	10/30	004 200 2	
8" (200)	Black	10/30 (5/15 PP)	004 200 3	050 200 3
10" (250)	Galvanized	10/30	004 250 1	
10" (250)	Zinc	10/30	004 250 2	
10" (250)	Black	10/30	004 250 3	

Galvanized hinges have brass pins . Pre-packed hinges come with screws.

### HD STANDARD TEE HINGES

SIZE INS (MM)	FINISH	QTY PER BOX	CODE	PRE-PACKED CODE
6" (150)	Black	10/40 (10/20 PP)	004 155 3	050 155 3
6" (150)	Black	20PRS	BRASS BUSHINGS	0501553BB

5/16" Hexscrew included.



### TEE HINGE WITH NYLON BUSHINGS

SIZE INS (MM)	FINISH	QTY PER BOX	CODE
6" (150)	Zinc	10/50	004 150 2-NYL

### HD TEE HINGE WITH NYLON BUSHINGS

SIZE INS (MM)	FINISH	QTY PER BOX	CODE
8" (200)	Zinc	10/40	004 200 2-NYL



### SQUARE TEE HINGE

SIZE INS (MM)	FINISH	PAIR PER BOX	CODE	PRE-PACKED CODE
5" (125)	Zinc	10/50		052 125 2
5" (125)	Black	10/50		052 125 3
6" (150)	Zinc	10/60 (5/30 PP)	602 150 2	052 150 2
6" (150)	Black	10/60 (5/30 PP)	602 150 3	052 150 3
8" (200)	Zinc	20		052 200 2
8" (200)	Black	20		052 200 3



Pre-packed hinges come with #10 x 1 1/2" screws

# STANDARD GATE COMPONENTS

HD OFFSET HINGES				
SIZE INS (MM)	FINISH	QTY PER BOX	CODE	PRE-PACKED CODE
3 1/2" (89)	Galvanized	10/60	602 001 1	
3 1/2" (89)	Zinc	10/60	602 001 2	
3 1/2" (89)	Black	10/60 (5/30 PP)	602 001 3	052 001 3

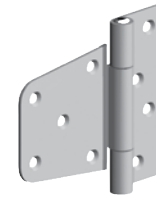
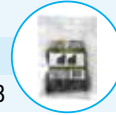

Galv. hinges have brass pins. Pre-packed hinges come with black hex screws.

HD OFFSET HINGES AUTO CLOSE			
SIZE INS (MM)	FINISH	PAIR PER BOX	CODE
3 1/2" (89)	Black	5/25	052 001 3-AC

Fasteners included.



DECORATIVE TEE HINGE WITH BUSHINGS			
SIZE INS (MM)	FINISH	PAIR PER BOX	CODE
5" (125)	Black	10/100	004 125 3
6" (150)	Black	10/50	004 150 3 D



ESTATE TEE HINGE				
DESCRIPTION	SIZE INS (MM)	FINISH	QTY PER BOX	CODE
Spring loaded	8" (200)	Black	20	004 222 3
Removable pin	8" (200)	Black	20	004 201 3
Fixed pin	8" (200)	Black	20	004 203 3

Fasteners included.



SELF-CLOSING ADJUSTABLE HINGE			
SIZE INS (MM)	FINISH	PAIR PER BOX	CODE
8" (200)	SS/Black	5/20	171 300 7

Fasteners included, heavy duty.



STAINLESS  
STEEL

FANCY TEE HINGES			
SIZE INS (MM)	FINISH	PAIR PER BOX	PRE-PACKED CODE
8" (200)	Black	10/20	050 205 3
10" (250)	Black	10	050 255 3

Fasteners included, heavy duty.



FANCY BUTTERFLY HINGE			
SIZE INS (MM)	FINISH	PAIR PER BOX	CODE
8" (200)	Black	10/20	005 055 3

Fasteners included, heavy duty.



# STANDARD GATE COMPONENTS



## ESTATE TEE HINGE

SIZE INS (MM)	FINISH	PAIR PER BOX	CODE
10"	Black	10	004 252 3
12"	Black	10	004 302 3



## FANCY STRAP HINGE

SIZE INS (MM)	FINISH	PAIR PER BOX	CODE
8" (200)	Black	10/20	005 205 3
10" (250)	Black	10	005 255 3

Fasteners included, heavy duty.



## NARROW STRAP HINGE

SIZE INS (MM)	FINISH	PAIR PER BOX	CODE
8" (200)	Black	20	055 200 3

Fasteners included, heavy duty.



## HALF STRAP HINGE

SIZE INS (MM)	FINISH	PAIR PER BOX	CODE
6" (150)	Black	30	055 150 3

Fasteners included, heavy duty.

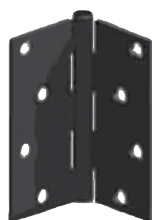

## BUTT HINGE

SIZE INS (MM)	FINISH	QTY PER BOX	CODE
4" (Removable Pin)	Galvanized	10/100	019 100 1
4" (Removable Pin)	Zinc	10/100	019 100 2
4" (Removable Pin)	Black	10/100	019 100 3
4.5" (Self Closing)	Steel	10	019 114 5
4.5" (Self Closing)	304 SS	10	019 114 6
4.5" (Self Closing)	SS/Black	10	019 114 7
4.5"	Galvanized	10/60	019 114 1
4.5"	Zinc	10/60	019 114 2
4.5"	Black	10/60	019 114 3

Packed in polythene sleeves - including screws.

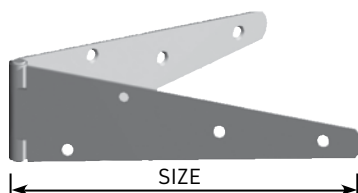

## HEAVY STRAP HINGES

SIZE INS (MM)	FINISH	QTY PER BOX	CODE
4" (100)	Galvanized	10/50	005 100 1
4" (100)	Zinc	10/50	005 100 2
4" (100)	Black	10/50	005 100 3
6" (150)	Galvanized	10/40	005 150 1
6" (150)	Zinc	10/40	005 150 2
6" (150)	Black	10/40	005 150 3
8" (200)	Galvanized	10/30	005 201 1
8" (200)	Zinc	10/30	005 201 2
8" (200)	Black	10/30	005 201 3

Galvanized hinges have brass pins.

# STANDARD GATE COMPONENTS

## SCREW HOOK AND EYE HINGE

SIZE INS	FINISH	QTY PER BOX	CODE
1/2" x 4"	Galvanized	50	085 102 1
1/2" x 4"	Black	50	085 102 3
5/8" x 5"	Galvanized	20	085 122 1
5/8" x 5"	Black	20	085 122 3



## HOOKS TO SCREW

PIN SIZE (MM)	SIZE INS (MM)	FINISH	QTY PER BOX	CODE
5/8" (16)	6" (150)	Galvanized	25	085 150 1
3/4" (19)	9" (250)	Galvanized	25	085 225 1

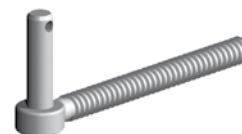

## J BOLT HANGER

SIZE INS (MM)	FINISH	QTY PER BOX	CODE
6" x 5/8" (150)	Zinc	10/50	601 658 2
10" x 5/8" (250)	Zinc	10/50	601 108 2
10" x 5/8" (250)	Galvanized	10/50	601 108 1



## EYE BOLT

SHANK DIA (MM)	LENGTH X PIN DIA	FINISH	QTY PER BOX	CODE
1/2" (12)	4 x 1/2" (100 x 12)	Galvanized	100	049 412 1
5/8" (16)	4 X 5/8" (100 X 16)	Galvanized	50	049 416 1
5/8" (16)	6 X 5/8" (150 X 16)	Galvanized	50	049 616 1
5/8" (16)	6 X 5/8" (150 X 16)	Zinc	50	049 616 2
3/4" (20)	4 X 3/4" (100 X 20)	Galvanized	25	049 420 1
3/4" (20)	6 x 3/4" (150 x 20)	Galvanized	25	049 620 1
3/4" (20)	8 x 3/4" (200 x 20)	Galvanized	25	049 820 1
3/4" (20)	10 x 3/4" (250 x 20)	Galvanized	25	049 120 1

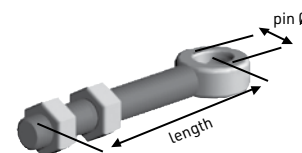

Other sizes available

## HANGER BOLTS

SIZE INS (MM)	FINISH	QTY PER BOX	CODE
12" x 1/2" (300 x 12)	Galvanized	10/30	612 121 1
12" x 1/2" (300 x 12)	Black	10/30	612 121 3
12" x 5/8" (300 x 16)	Galvanized	10/30	612 158 1
12" x 5/8" (300 x 16)	Black	10/30	612 158 3
12" x 3/4" (300 x 20)	Galvanized	10/30	612 134 1
12" x 3/4" (300 x 20)	Black	10/30	612 134 3



Comes with 2 nuts and 2 washers



# STANDARD GATE COMPONENTS

## LATCHES

HD POST MOUNT GATE LATCH				
SIZE INS (MM)	DESCRIPTION	FINISH	QTY PER BOX	CODE
10 1/2" (265)		Zinc	30	602 007 2
10 1/2" (265)		Black	30	602 007 3
10 1/2" (265)	with bracket	Black	30	602 027 3-C
10 1/2" (265)	with handle	Black	30	602 037 3
10 1/2" (265)	unassembled	Black	30	602 027 3

Fasteners included. 2-sided entry.



OPTIMA POST LATCH				
SIZE INS (MM)	FINISH	QTY PER BOX	CODE	
9" (225)	Black	10/20	602 017 3	

Fasteners included, pad lockable, locking feature.



FLOATING BAR LATCH				
SIZE INS (MM)	FINISH	QTY PER BOX	CODE	
2" (50)	Zinc	10/50	601 003 2	
2" (50)	Black	10/50	601 003 3	

Fasteners included, pad lockable.



HD FLOATING BAR LATCH				
SIZE INS (MM)	FINISH	QTY PER BOX	CODE	
3" (75)	Black	5/25	601 004 3	

Fasteners included, pad lockable.



ROUND RAIL LOOP LATCH				
SIZE INS (MM)	FINISH	QTY PER BOX	CODE	
10" (250)	Zinc	10/60	189 100 2	

Post and rail fencing, heavy duty. Fasteners included.



SPLIT RAIL LOOP LATCH				
SIZE INS (MM)	FINISH	QTY PER BOX	CODE	
8" (200)	Zinc	10/60	189 200 2	

Fasteners included.



LOCKABLE THUMB LATCH				
SIZE INS (MM)	FINISH	QTY PER BOX	CODE	
10 1/2" (255)	Black	5/30	602 008 3	
10 1/2" (255)	Black	5/30	602 018 3	FLAT BAR

Fasteners included.



# STANDARD GATE COMPONENTS



## LOOPED RING GATE LATCH

SIZE INS (MM)	FINISH	QTY PER BOX	CODE
2" (50)	Zinc	10/100	602 005 2

Packed in polythene sleeves - including screws.



## CAPE COD LATCH

SIZE	FINISH	QTY PER BOX	CODE
Heavy	Galvanized	5	099 000 1
Heavy	Black	5	099 000 3

For post and rail application.



## DUMPSTER LATCH

SIZE INS (MM)	FINISH	QTY PER BOX	CODE
4 1/2" (115)	Black	10	602 114 3

Pad-lockable, fasteners included.



## AUTO LATCH/BIG MOUTH

SIZE INS (MM)	FINISH	QTY PER BOX	CODE
2" (50)	Galvanized	10/100	601 001 1
2" (50)	Zinc	10/100	601 001 2
2" (50)	Black	10/100	601 001 3
2" (50 mm)	304 SS	10/100	601 0016
2" (50 mm)	SS/Black	10/100	601 0017
2" (50 mm)	SS/White	10/100	601 0010

Fasteners included.



## AUTO LATCH WITH 90° STRIKE

SIZE INS (MM)	FINISH	QTY PER BOX	CODE
2" (50)	Zinc	10/100	601 000 2
2" (50)	Black	10/100	601 000 3

Fasteners included.



## HD AUTO LATCH

DESCRIPTION	FINISH	QTY PER BOX	CODE
3" (75) with Cable	Galvanized	5/30	602 110 1
3" (75) with Cable	Zinc	5/30	602 110 2
3" (75) with Cable	Black	5/30	602 110 3
3" (75) w/o Cable	Zinc	5/30	602 110 2H
3" (75) w/o Cable	Black	5/30	602 110 3H

Fasteners included.

# STANDARD GATE COMPONENTS

## AUTO LATCH WITH CABLE

SIZE INS (MM)	FINISH	QTY PER BOX	CODE
2" (50)	Galvanized	10/100	601 101 1
2" (50)	Zinc	10/100	601 101 2
2" (50)	Black	10/100	601 101 3

Fasteners included.



## TOP MOUNT GATE LATCH

SIZE INS (MM)	FINISH	QTY PER BOX	CODE
4 1/2" (105)	Zinc	10/50	602 011 2
4 1/2" (105)	Black	10/50	602 011 3

Fasteners included.

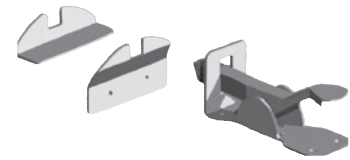

## BOLTS

### CANE BOLTS

SIZE INS (MM)	FINISH	QTY PER BOX	CODE
12" x 1/2" (300)	Galvanized	10/30	602 004 1
12" x 1/2" (300)	Zinc	10/30	602 004 2
12" x 1/2" (300)	Black	10/30	602 004 3
18" x 1/2" (450)	Galvanized	10/30	602 003 1
18" x 1/2" (450)	Zinc	10/30	602 003 2
18" x 1/2" (450)	Black	10/30	602 003 3
24" x 1/2" (600)	Black	10/20	602 600 3
24" x 5/8" (600)	Zinc	10/20	602 015 2
24" x 5/8" (600)	Black	10/20	602 015 3
36" x 5/8" (900)	Zinc	1/10	602 915 2
36" x 5/8" (900)	Black	1/10	602 915 3
36" x 1/2" (900)	Black	1/10	602 900 3
48" x 1/2" (1200)	Black	1/10	602 120 3

Fasteners included.



### SLIDE BOLTS

SIZE INS (MM)	FINISH	QTY PER BOX	CODE
6" (150)	Galvanized	10/80	602 002 1
6" (150)	Zinc	10/80	602 002 2
6" (150)	Black	10/80	602 002 3

Fasteners included.



### SPRING LOADED BOLTS (GLOW IN THE DARK HANDLE) - SHORT BODY

SHOOT DIA INS (MM)	LENGTH INS (MM)	FINISH	QTY PER BOX	CODE
3/8" (9.5)	2 1/2" (60)	E-Galvanized	10	110 395 2
1/2" (12)	3" (75)	E-Galvanized	10	110 312 2



# STANDARD GATE COMPONENTS

## HANDLES



PULL HANDLE			
SIZE INS (MM)	FINISH	QTY PER BOX	CODE
8" (200)	Galvanized	10/100	147 175 1
8" (200)	Zinc	10/100	147 175 2
8" (200)	Black	10/100	147 175 3

Fasteners included.



GATE HANDLE			
SIZE INS (MM)	FINISH	QTY PER BOX	CODE
8" (200)	Black	10/100	147 200 3

Fasteners included.



ROUNDED GATE HANDLE			
SIZE INS (MM)	FINISH	QTY PER BOX	CODE
6" (150)	Black	10/30	147 150 3

Stainless Steel Fasteners included.



GATE HANDLE (TO GO WITH POST LATCH)			
SIZE INS (MM)	FINISH	QTY PER BOX	CODE
9" (225)	Black	10/100	147 225 3

Fasteners included.



THUMB HANDLE			
SIZE INS (MM)	FINISH	QTY PER BOX	CODE
10 1/2" (255)	Black	10/100	602 008 3-A

Does not include screws .

## GATE CLOSERS



GATE RETURN SPRING			
SPRING LENGTH	FINISH	QTY PER BOX	CODE
8" (200)	Zinc	10/40	526 200 2
8" (200)	Black	10/40	526 200 3
10" (250)	Zinc	10/40	526 250 2
10" (250)	Black	10/40	526 250 3

Fasteners included.

# STANDARD GATE COMPONENTS

## HYDRAULIC GATE CLOSER

SIZE INS (MM)	FINISH	QTY PER BOX	CODE
12" (300)	Black	8	134 300 3

Fasteners and instructions included.  
More Gate Closer options on page 54.



## GATE WHEELS

### HEAVY DUTY SPRING LOADED GATE WHEEL

SIZE INS (MM)	FINISH	QTY PER BOX	CODE
14 1/2" (370)	Galvanized	1/5	081 368 1
14 1/2" (370)	Zinc	1/5	081 368 2
14 1/2" (370)	Black	1/5	081 368 3

Packed in polythene sleeves - carriage bolts included.

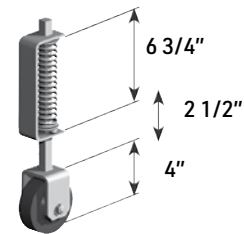

### MEDIUM SPRING LOADED GATE WHEEL

SIZE INS (MM)	FINISH	QTY PER BOX	CODE
11" (280)	Zinc	1/5	081 280 2

Swivels



## HARDWARE KITS

### ANTI-SAG KIT

SIZE INS (MM)	FINISH	QTY PER BOX	CODE
120"	Zinc	10/100	188 100 2
120"	Black	10/100	188 100 3

Fasteners included.

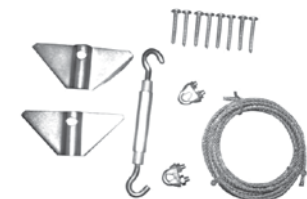

### GATE HARDWARE KIT

FINISH	QTY PER BOX	CODE
Black	1 SET/20 SETS	098 150 3

INCLUDES: Auto Latch with Cable (6011013), 8" Pull Handle (1471753),  
Pair of 6" Tee Hinges (0501503)  
All fasteners included. Comes in retail box.



# STANDARD GATE COMPONENTS

## WALK GATE KITS

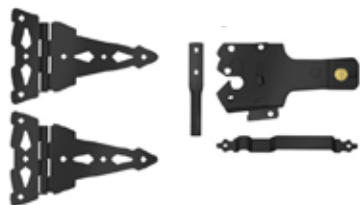

### WALK GATE KIT- 2 HINGE WITH OPTIMA

SIZE INS (MM)	FINISH	QTY PER BOX	CODE
8"	Black	10	7042053-20P



### WALK GATE KIT - 2 HINGE

SIZE INS (MM)	FINISH	QTY PER BOX	CODE
8"	Black	10	7052053-2H



### WALK GATE KIT - 3 HINGE

SIZE INS (MM)	FINISH	QTY PER BOX	CODE
8"	Black	10	7052053-3H

## MISCELLANEOUS



### WOOD TO STEEL POST ADAPTER

SIZE INS (MM)	FINISH	QTY PER BOX	CODE
2 3/8" (60)	Zinc	100	W2S238Z

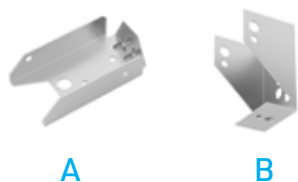

### FENCE CLIP

SIZE INS (MM)	FINISH	QTY PER BOX	CODE
2" (50)	Zinc	150	FB24G (A)
2" (50)	HDG	150	FB24HDG (A)
2" (50)	Black	300	FB24G-BK (A)
2" (50)	Zinc	400	FB24GR (B)
2" (50)	Black	400	FB24GR-BK (B)



### STEEL DOOR PULL (BAR HOLDER)

SIZE INS (MM)	FINISH	QTY PER BOX	CODE
6 1/2" (165)	Zinc	10/60	191 150 2



# GATE FRAMES

Premade iron gates and gate frames.  
Both adjustable for quick and easy installation.



# GATE FRAME COMPONENTS

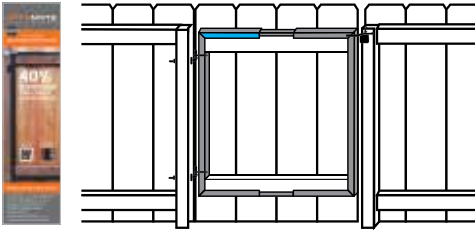

## ADJUSTABLE GATE FRAME

SIZE INS	FINISH	QTY PER BOX/PALLET	CODE
24" - 51" Expanding	Black	1/26	701 000 3

All hardware included. Includes Hanger bolts and latch.  
Quick and strong assembly.  
Installation videos available at [www.abbeyhardware.com](http://www.abbeyhardware.com)

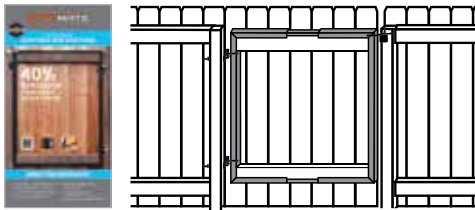

## ADJUSTABLE WIDE GATE FRAME

SIZE INS	FINISH	QTY PER BOX/PALLET	CODE
48" - 84" Expanding	Black	1/12	702 000 3

All hardware included. Includes Hanger bolts, latch and drop rod.  
Quick and strong assembly.  
Installation videos available at [www.abbeyhardware.com](http://www.abbeyhardware.com)

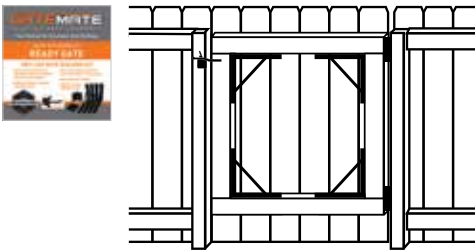

## READY GATE (ANTI-SAG KIT)

SIZE INS	FINISH	QTY PER BOX	CODE
For 25" - 72" Gate Openings	Black	1/5	705 000 3



All hardware included





# TRADITIONAL HARDWARE

This section features a comprehensive range of gate and door hardware to enhance custom gates. Other uses include sheds, barn doors, and farm/ag applications.



## HINGES



### STRONG TEE HINGES

SIZE INS (MM)	FINISH	PAIRS PER BOX	CODE
12" (300)	Galvanized	5	503 300 1
12" (300)	Black	5	503 300 3
12" (300)	316 SS Brushed Matte	5	505 300 6
18" (450)	Galvanized	5	503 450 1
18" (450)	Black	5	503 450 3
24" (600)	Galvanized	5	503 600 1
24" (600)	Black	5	503 600 3



### CRANKED BANDS & HOOKS ON PLATES

SIZE INS (MM)	FINISH	PAIRS PER BOX	CODE
8" (200)	Galvanized	5	507 200 1
8" (200)	Black	5	507 200 3
12" (300)	Galvanized	5	507 300 1
12" (300)	Black	5	507 300 3
18" (450)	Galvanized	5	507 450 1
18" (450)	Black	5	507 450 3
18" (450)	316 SS Brushed Matte	5	507 450 6
24" (600)	Galvanized	2	507 600 1
24" (600)	Black	2	507 600 3
24" (600)	316 SS Brushed Matte	1	507 600 6
30" (750)	Galvanized	2	507 750 1
30" (750)	Black	2	507 750 3
36" (900)	Galvanized	2	507 900 1
36" (900)	Black	2	507 900 3



### CRANKED BANDS & HOOKS WITH NYLON BUSHINGS

SIZE INS (MM)	FINISH	PAIRS PER BOX	CODE
12" (300)	Black	5	507 300 3-NYL

Patent # D862,197



### TRADITIONAL HINGE FRONT

SIZE INS (MM)	FINISH	PAIRS PER BOX	CODE
12" (300)	Black	1/5	506 305 3
18" (450)	Black	1/5	506 455 3
24" (600)	Black	1/5	506 605 3

# TRADITIONAL HARDWARE

## STRAIGHT BANDS & HOOKS

SIZE INS (MM)	FINISH	PAIRS PER BOX	CODE
8 x 1/2" (200)	Galvanized	5	506 201 1
8 x 1/2" (200)	Black	5	506 201 3
12 x 5/8" (300)	Galvanized	5	506 301 1
12 x 5/8" (300)	Black	5	506 301 3
18 x 3/4" (450)	Galvanized	5	506 451 1
18 x 3/4" (450)	Black	5	506 451 3
24 x 3/4" (600)	Galvanized	2	506 601 1
24 x 3/4" (600)	Black	2	506 601 3



## ADJUSTABLE BANDS & HOOKS ON PLATES

SIZE INS (MM)	FINISH	PAIRS PER BOX	CODE
12" (300)	Galvanized	5	508 300 1
12" (300)	Black	5	508 300 3
14" (355)	Galvanized	5	508 350 1
14" (355)	Black	5	508 350 3
18" (450)	Galvanized	5	508 450 1
18" (450)	Black	5	508 450 3
18" (450)	316 SS Brushed Matte	1	508 450 6
24" (600)	Galvanized	2	508 600 1
24" (600)	Black	2	508 600 3
24" (600)	316 SS Brushed Matte	1	508 600 6
36" (900)	Galvanized	1	508 900 1



## HEAVY REVERSIBLE HINGES

SIZE INS (MM)	FINISH	PAIRS PER BOX	CODE
7" (175)	Galvanized	5	509 175 1
7" (175)	Black	5	509 175 3
12" (300)	Galvanized	5	509 300 1
12" (300)	Black	5	509 300 3
18" (450)	Galvanized	5	509 450 1
18" (450)	Black	5	509 450 3
24" (600)	Galvanized	2	509 600 1
24" (600)	Black	2	509 600 3
30" (750)	Galvanized	2	509 750 1
30" (750)	Black	2	509 750 3
36" (900)	Galvanized	2	509 900 1
36" (900)	Black	2	509 900 3
42" (1050)	Galvanized	1	509 105 1
42" (1050)	Black	1	509 105 3



# TRADITIONAL HARDWARE

PATENT  
#D792,753



## HEAVY REVERSIBLE HINGES WITH NYLON BUSHINGS

SIZE INS (MM)	FINISH	PAIRS PER BOX	CODE
12" (300)	Black	1/5	509 300 3NYL
18" (450)	Black	1/5	509 450 3NYL
24" (600)	Black	1/5	509 600 3NYL



## CURVED RAIL HINGE KITS - HANDED

SIZE INS (MM)	FINISH	PAIRS PER BOX	HAND	CODE
12" (300)	Black	5	L/H	598 000 3
12" (300)	Black	5	R/H	598 001 3

Specify Left or Right handed kit when ordering.

RIGHT-HANDED OPTION SHOWN

## PRE-PACKED BOLTS



### 1/2" BRENTON PADBOLTS

SIZE INS (MM)	FINISH	QTY PER BOX	CODE
4" x 1/2" (100)	Zinc	5	512 100 2
4" x 1/2" (100)	Black	5	512 100 3
6" x 1/2" (150)	Galvanized	5	512 150 1
6" x 1/2" (150)	Black	5	512 150 3
6" x 1/2" (150)	316 SS Brushed Matte	1	512 150 6
8" x 1/2" (200)	Galvanized	5	512 200 1
8" x 1/2" (200)	Black	5	512 200 3

Use with padlock - see page 54. Padlockable.

### 5/8" HEAVY DUTY BRENTON PADBOLTS

SIZE INS (MM)	FINISH	QTY PER BOX	CODE
8" x 5/8" (200)	316 SS Brushed Matte	1	513 200 6
10" x 5/8" (250)	Galvanized	5	513 250 1
12" x 5/8" (300)	Galvanized	5	513 300 1

Use with padlock - see page 54. Padlockable.

# TRADITIONAL HARDWARE

## GARAGE DOOR BOLTS

SIZE INS (MM)	FINISH	QTY PER BOX	CODE
12" x 5/8" (300)	Galvanized	5	520 300 1
12" x 5/8" (300)	Black	5	520 300 3
18" x 5/8" (450)	Galvanized	5	520 450 1
18" x 5/8" (450)	Black	5	520 450 3
24" x 5/8" (600)	Galvanized	5	520 600 1
24" x 5/8" (600)	Black	5	520 600 3
36" x 5/8" (900)	Galvanized	5	520 900 1
36" x 5/8" (900)	Black	5	520 900 3
48" x 5/8" (120)	Galvanized	5	520 120 1
48" x 5/8" (120)	Black	5	520 120 3



## HEAVY LOCKING GARAGE DOOR BOLTS

SIZE INS (MM)	FINISH	QTY PER BOX	CODE
18" x 5/8" (450)	Galvanized	10	117 450 1
18" x 5/8" (450)	Black	10	117 450 3
18" x 5/8" (450)	316 SS Brushed Matte	1	117 450 6
24" x 3/4" (600)	Galvanized	1	117 600 1



Use with padlock - see page 54. Padlockable.

## OVAL PADBOLTS

SIZE INS (MM)	FINISH	QTY PER BOX	CODE
4" (100)	Galvanized	5	514 100 1
4" (100)	Black	5	514 100 3



Use with padlock - see page 54. Padlockable.

## TOWER BOLTS

SIZE INS (MM)	FINISH	QTY PER BOX	CODE
4" (100)	Galvanized	5	510 100 1
4" (100)	Zinc	5	510 100 2
4" (100)	Black	5	510 100 3
6" (150)	Galvanized	5	510 150 1
6" (150)	Zinc	5	510 150 2
6" (150)	Black	5	510 150 3



# TRADITIONAL HARDWARE

## HANDLES AND LATCHES



### DOOR-GATE HANDLE

SIZE INS (MM)	FINISH	QTY PER BOX	CODE
6" (150)	Galvanized	5	537 150 1
6" (150)	Black	5	537 150 3
8" (200)	Black	5	537 200 3



### LARGE AUTO GATE CATCHES

SIZE	FINISH	QTY PER BOX	CODE
Large	Galvanized	5	521 002 1
Large	Black	5	521 002 3

HEAVY  
BACKPLATE



### WINDSOR LATCHES

SIZE	FINISH	QTY PER BOX	CODE
Heavy	Galvanized	5	123 003 1
Heavy	Black	5	123 003 3
Heavy	316 SS Brushed Matte	1	523 003 6

Suitable for up to 3" thick doors or gates. Self-latching.  
Comes with [PADLOCK EYES](#)



HEAVY  
BACKPLATE



### SUFFOLK LATCHES

SIZE	FINISH	QTY PER BOX	CODE
Heavy	Galvanized	5	523 002 1
Heavy	Black	5	523 002 3

Suitable for up to 3" thick doors or gates. Self-latching.  
Comes with [PADLOCK EYES](#)



LEFT-HANDED OPTION SHOWN

### NORTHAM GATE LATCH

SIZE INS (MM)	FINISH	QTY PER BOX	HAND	CODE
7" (175)	Black	10	L/H	130 001 3
7" (175)	Black	10	R/H	130 002 3
7" (175)	Galvanized	10	L/H	130 001 1
7" (175)	Galvanized	10	R/H	130 002 1

# TRADITIONAL HARDWARE

## CABIN HOOKS WIRE PATTERN

SIZE INS (MM)	FINISH	QTY PER BOX	CODE
4" (100)	Galvanized	5	532 100 1
4" (100)	Black	5	532 100 3
6" (150)	Galvanized	5	532 150 1
6" (150)	Black	5	532 150 3
8" (200)	Galvanized	5	532 200 1
8" (200)	Black	5	532 200 3
12" (300)	Galvanized	5	532 300 1
12" (300)	Black	5	532 300 3



## TWISTED RING GATE LATCHES

SIZE INS (MM)	FINISH	QTY PER BOX	CODE
6" (150)	Galvanized	5	524 150 1
6" (150)	Black	5	524 150 3

Suitable for up to 3" thick doors or gates  
For thicker applications, use Extension Spindle, page 35  
Comes with [PADLOCK EYES](#)



## TWISTED RING HANDLE ONLY

SIZE INS (MM)	FINISH	QTY PER BOX	CODE
3 1/2" (87)	Galvanized	5	524 150 1 A
3 1/2" (87)	Black	5	524 150 3 A



## CRAFTSMAN RING GATE LATCH

SIZE INS (MM)	FINISH	QTY PER BOX	CODE
6" (150)	Black	5	525 155 3
6" (150)	Brushed Matte	1	525 155 6

Suitable for up to 3" thick doors or gates. Self-latching.  
For thicker applications, use Extension Spindle, page 35  
Comes with [PADLOCK EYES](#)



## CRAFTSMAN RING HANDLE

SIZE INS (MM)	FINISH	QTY PER BOX	CODE
3 1/2" (87)	Black	5	525 155 3 A



# TRADITIONAL HARDWARE



## MODERN 2-WAY LEVER LATCH

SIZE	FINISH	QTY PER BOX	CODE
3 1/4"	Alum / Black	18	525 107 6

Outswing or inswing. RH or LH Reversible Aluminium Latch with steel reciever.

## MISCELLANEOUS

EXTERIOR  
USE



## HANDRAIL BRACKETS

SIZE INS (MM)	FINISH	QTY PER BOX	CODE
3" (75)	Galvanized	10	180 075 1
3" (75)	Zinc	10	180 075 2
3" (75)	Black	10	180 075 3

3" meets new county code standar

FOR TIGHTENING FENCING CABLE



## TURN BUCKLES

SIZE INS (MM)	FINISH	QTY PER BOX	CODE
1/4" (6)	Zinc	10	211 006 2
5/16" (8)	Zinc	10	211 008 2
3/8" (10)	Zinc	10	211 010 2
1/2" (12)	Zinc	10	211 012 2

FOR USE  
IN STABLES



## RINGS ON HEAVY DUTY PLATES – EQUESTRIAN

SIZE INS (MM)	FINISH	QTY PER BOX	CODE
2" x 2" (50 x 50)	Galvanized	10	246 050 1
4" x 2" (100 x 50)	Black	10	246 150 3

Other sizes available



*We guarantee the performance and quality of every one of our products.*

## PRE-PACKED HASPS & STAPLES

### SAFETY PATTERN HASPS & STAPLES

SIZE	FINISH	QTY PER BOX	CODE
3" (75)	E-Galvanized	5	533 075 2
3" (75)	Black	5	533 075 3
4" (100)	E-Galvanized	5	533 100 2
4" (100)	Black	5	533 100 3
6" (150)	E-Galvanized	5	533 150 2
6" (150)	Black	5	533 150 3



### HEAVY HASPS & STAPLES

SIZE	FINISH	QTY PER BOX	CODE
8" (200)	Galvanized	5	535 200 1
8" (200)	Black	5	535 200 3

Galvanized has brass pin



### HEAVY SAFETY PATTERN HASP & STAPLE

SIZE	FINISH	QTY PER BOX	CODE
7" (180)	Galvanized	5	538 180 1
7" (180)	Black	5	538 180 3



### HEAVY HASP & STAPLES VERTICAL PATTERN

SIZE	FINISH	QTY PER BOX	CODE
6" (150)	Galvanized	5	534 150 1
6" (150)	Black	5	534 150 3







# POLYMER & VINYL GATE HARDWARE

Featuring a versatile range of gate hardware for vinyl applications as well as swimming pool enclosures. Fasteners included with products in this section, except otherwise noted.



# POLYMER & VINYL GATE HARDWARE

All Fasteners Included

## VINYL GATE HARDWARE



### ADJUSTABLE HINGE NARROW TO NARROW (Self-Closing)

SIZE INS	FINISH	PRS PER BOX	CODE
3 1/2"	Steel/Black	12	171 089 3
3 1/2"	Steel/White	12	171 089 4
3 1/2"	Stainless/Black	12	171 089 7
3 1/2"	Stainless/White	12	171 089 0



### S/S ADJUSTABLE STANDARD TO NARROW HINGES (Self-Closing)

SIZE INS	FINISH	PRS PER BOX	CODE
3 1/2"	Stainless/Black	12	171 002 7
3 1/2"	Stainless/White	12	171 002 0



### ADJUSTABLE MIXED PROFILE HINGES (Self-Closing)

SIZE INS	FINISH	PRS PER BOX	CODE
2"	Steel/Black	12	171 077 3
2"	Steel/Black	12	171 077 4
2"	Stainless/Black	12	171 077 7
2"	Stainless/White	12	171 077 0



### S/S WRAP AROUND STRAP HINGE STANDARD TO NARROW (Self-Closing)

SIZE INS	FINISH	PRS PER BOX	CODE
8"	Stainless/Black	6	171 200 7



### STEEL ADJUSTABLE HINGES NARROW TO NARROW (Not Self-Closing)

SIZE INS	FINISH	PRS PER BOX	CODE
3"	Black	12	172 089 3
3"	White	12	172 089 4



### STEEL WRAP AROUND ADJUSTABLE HINGE STANDARD TO NARROW (Not Self-Closing)

SIZE INS	FINISH	PRS PER BOX	CODE
1 3/4"	Black	12	172 044 3
1 3/4"	White	12	172 044 4
2"	Black	12	172 076 3
2"	White	12	172 076 4

# POLYMER & VINYL GATE HARDWARE

All Fasteners Included

## WRAP AROUND ADJUSTABLE HINGE STANDARD TO NARROW (Self Closing)

SIZE	FINISH	QTY PER BOX	CODE
1 1/2"	Steel/Black	12	171 038 3
1 3/4"	Steel/Black	12	171 044 3
1 3/4"	Steel/Black	12	171 044 4
2"	Steel/Black	12	171 036 3
2"	Steel/Black	12	171 046 3



## HD ADJUSTABLE HINGE STANDARD TO STANDARD (Not Self Closing)

SIZE INS	FINISH	QTY PER BOX	CODE
3 1/2"	Steel/Black	10	172 090 3
3 1/2"	Steel/White	10	172 090 4
3 1/2"	SS/Black	10	172 090 7



## STEEL POST LATCH FOR VINYL

SIZE INS	FINISH	QTY PER BOX	CODE
9"	Steel/Black	20	383 007 3
9" (Straight Handle)	Steel/Black	20	383 007 3SH
9"	Steel/White	20	383 007 4
9"	Stainless/Black	20	383 007 7
9"	Stainless/White	20	383 007 0



## STAINLESS STEEL TWISTED RING GATE LATCH

SIZE INS	FINISH	QTY PER BOX	CODE
8 1/2"	Stainless/Black	12	524 155 7



## STEALTH POST LATCH

SIZE INS	FINISH	QTY PER BOX	CODE
8 1/2"	Steel/Black	12	383 215 3
8 1/2"	Steel/White	12	383 215 4
8 1/2"	SS/Black	12	383 215 7
8 1/2"	SS/White	12	383 215 0



## 5" LATCH FOR DOUBLE VINYL GATE

SIZE INS	FINISH	QTY PER BOX	CODE
5"	Steel/Black	20	383 125 3
5"	Steel/White	20	383 125 4
5"	SS/Black	20	383 125 7
5"	SS/White	20	383 125 0



# POLYMER & VINYL GATE HARDWARE

All Fasteners Included



## CANE BOLT FOR VINYL & WOOD

SIZE INS	FINISH	QTY PER BOX	CODE	WITH CRADLE
24" x 5/8"	Steel/Black	10	603 600 3	603 600 3-C
24" x 5/8"	Steel/White	10	603 600 4	603 600 4-C
24" x 5/8"	SS/Black	10	603 015 7	603 015 7-C
24" x 5/8"	SS/White	10	603 015 0	603 015 0-C
36" x 5/8"	Steel Black	10	603 900 3	603 900 3-C
36" x 5/8"	Steel White	10	603 900 4	603 900 4-C
36" x 5/8"	SS/Black	10	603 900 7	603 900 7-C
36" x 5/8"	SS/White	10	603 900 0	603 900 0-C
42" x 5/8"	Steel/Black	10	603 105 3	
42" x 5/8"	Steel/White	10	603 105 4	
42" x 5/8"	SS/Black	10	603 105 7	
42" x 5/8"	SS/White	10	603 105 0	



## STEEL GATE WHEEL FOR VINYL

SIZE INS	FINISH	QTY PER BOX	CODE
11 1/2"	Steel Black	10	081 288 3
11 1/2"	Steel White	10	081 288 4



## GATE SPRING FOR VINYL

SIZE INS	FINISH	QTY PER BOX	CODE
13"	Steel Black	20	526 330 3
13"	Steel White	20	526 330 4
13"	Stainless/Black	20	526 330 7
13"	Stainless/White	20	526 330 0

## POLYMER GATE HARDWARE



## TRUCLOSE® REGULAR-MINI MULTI ADJUST

GATE GAP SIZE	FINISH	QTY PER BOX	CODE
7/8" - 1 1/2"	Black	10	TCAMA1
7/8" - 2"	Black	10	TCAMA2
7/8" - 2" (ROUND POST)	Black	10	TCAMA2-RND

3-way adjustment: vertical, horizontal & tension.

Regular models self-close gates up to 55lb.

\*Heavy Duty model self-close gates up to 132lb available.

# POLYMER & VINYL GATE HARDWARE

All Fasteners Included

## KEYSTONE® ADVANTAGE TWO-SIDED

DESCRIPTION	FINISH	QTY PER BOX	CODE
Metal, For Posts: 2" to 6"	Black	20	KLADV M2 BK
Nylon, For Posts: 2" to 6"	Black	20	KLADV P2 BK



## KEYSTONE® EXTERNAL MOUNT TWO-SIDED

DESCRIPTION	FINISH	QTY PER BOX	CODE
Nylon, For Posts: 2" to 5"	Black	20	KLX P2 BK
Nylon, For Posts: 2" to 5"	White	20	KLX P2 WH



## LOKKLATCH® DELUXE (External Access Kit Included)

VARIABLE	FINISH	QTY PER BOX	CODE
Keyed Alike	Black	10	LLD3KA
Keyed Different	Black	10	LLD3KD

Metal, wood, & vinyl applications  
Rekeyable (to match door locks)  
Operates and locks from both sides of gate  
Also available in white



## LOKKLATCH® REGULAR

VARIABLE	FINISH	QTY PER BOX	CODE
Latch only	Black	10	LL3AL
Latch & External Access Kit	Black	10	LL3ABL

Metal, Wood, & Vinyl Applications  
Locking The External Access Button Does Not Simultaneously Lock The Main Latch  
Can Be Used Round Post Adapter Kit  
Also Available In White



## MAGNALATCH® SERIES 3 - TOP PULL 6 PIN LOCK KEYED ALIKE

SIZE	FINISH	QTY PER BOX	CODE
20 1/2"	Black	10	ML3TPKA
10"	Black	10	ML3VPA

6-pin lock for higher security (re-keyable to match doors & gate locks).  
Vertically & horizontally adjustable.  
\*Visual & Audible Alert, White, and Round-Post Adaptor Kit options available.



# POLYMER & VINYL GATE HARDWARE

All Fasteners Included



## ROUND POST ADAPTER FOR CHAIN LINK (Adapter for the AquaLatch®)

SIZE INS	FINISH	QTY PER BOX	CODE
Gate Frame: 1 3/8," 1 5/8"	Black	20	NW6149 BK
Fence Post: 1 7/8," 2," 2 3/8," 2 5/8," 2 7/8"			



## AQUALATCH - POOL SAFETY LATCH

SIZE INS	FINISH	QTY PER BOX	CODE
20"	Black	20	AQUA 20 BK
10"	Black	20	AQUA 10 BK

Gate Frame Fence Post: 2" to 5"



## LOCKBOLT® PREMIUM DROP-BOLT

SIZE	FINISH	QTY PER BOX	CODE
24"	Black	6	LB224BX

6-pin lock (rekeyable to match doors & gate locks).  
316 marine-grade stainless steel drop-rod.  
\*18", Base Plate, and White options available.



## GATE HANDLE FOR VINYL

SIZE INS	FINISH	QTY PER BOX	CODE
5"	Nylon Black	50	148 127 3
5"	Nylon White	50	148 127 4



## GATE HANDLE WITH BUMPER

SIZE INS	FINISH	QTY PER BOX	CODE
4.5"	Nylon Black	50	148 120 3
4.5"	Nylon White	50	148 120 4



We guarantee the performance and quality of every one of our products.



# ALUMINUM GATE HARDWARE

Featuring a versatile range of gate hardware for aluminium applications. Fasteners included with products in this section, except otherwise noted.



# ALUMINUM GATE HARDWARE

All Fasteners Included



## SELF CLOSING ALUMINUM HINGE

SIZE INS	FINISH	PRS PER BOX	CODE
5 3/4"	Black	20	196 150 3
5 3/4"	White	20	196 150 4



## SELF CLOSING ALUMINUM HINGE

SIZE INS	FINISH	PRS PER BOX	CODE
4"	Aluminium/Black	25	196 100 3
4"	Aluminium/White	25	196 100 4
4"	Aluminium/Bronze	25	196 100 8



## GATE LATCH FOR ALUMINIUM

SIZE INS	FINISH	QTY PER BOX	CODE
3 1/4"	SS/Black	20	386 150 7
3 1/4"	SS/White	20	386 150 0



## ADJUSTABLE SELF CLOSING HINGE

SIZE INS	FINISH	PRS PER BOX	CODE
1 3/8"	Steel/Black	20	171 133 3
1 3/8"	SS/Black	20	171 133 7



## CANE BOLT FOR ALUMINIUM

SIZE INS	FINISH	QTY PER BOX	CODE
24" x 5/8"	Steel/Black	10	604 600 3
36" x 5/8"	Steel/Black	10	604 900 3



## ADJUSTABLE SELF CLOSING

SIZE INS	FINISH	PRS PER BOX	CODE
3 1/2"	Black	50	196 090 3



## SMALL SELF CLOSING NYLON HING

SIZE INS	FINISH	PRS PER BOX	CODE
3"	Black	40	196 075 3



# ANTIQUE IRONMONGERY

This section features an extensive range of Hand Crafted old world style wood gate & door hardware. Other uses include shutters, garage doors, furniture, and cabinet applications. All Antique Ironmongery finished with a quality, heavy black powder coat over zinc plate. Comes with stainless steel screws.



# ANTIQUE IRONMONGERY



## ANTIQUE TEE HINGES

SIZE INS (MM)	FINISH	PAIRS PER BOX	CODE
6" (150)	Dull Black	5	550 150 3
9" (225)	Dull Black	5	550 225 3
12" (300)	Dull Black	5	550 300 3



## ANTIQUE COLONIAL HINGES

SIZE INS (MM)	FINISH	PAIRS PER BOX	CODE
12" (300)	Dull Black	5	574 300 3
18" (450) Heavy Duty	Dull Black	5	574 450 3
24" (600) Heavy Duty	Dull Black	5	574 600 3



## ANTIQUE HEAVY DUTY FLEUR-DE-LYS HINGES

SIZE INS (MM)	FINISH	PAIRS PER BOX	CODE
16" (400)	Dull Black	5	551 400 3



## ANTIQUE COLONIAL HINGE FRONTS ONLY

SIZE INS (MM)	FINISH	PAIRS PER BOX	CODE
9" (225)	Dull Black	5	554 225 3
12" (300)	Dull Black	5	554 303 3
18" (450)	Dull Black	5	554 450 3
24" (600)	Dull Black	5	554 600 3



## ANTIQUE HOOK & BAND HINGES

SIZE INS (MM)	FINISH	PAIRS PER BOX	CODE
12" (300)	Dull Black	5	563 300 3
18" (450)	Dull Black	5	563 450 3
24" (600)	Dull Black	5	563 600 3



## ANTIQUE LEVER LOCK HANDLE

SIZE INS (MM)	FINISH	PAIRS PER BOX	CODE
6" x 2" (150x50)	Dull Black	5	555 150 3

Suitable for up to 3" thick doors or gates. Recommended for use with Mortise Sash Lock below. For thicker applications, use Extension Spindle, page 35. Can be used on French doors.



## ANTIQUE LEVER LOCK HANDLE F.D.L.

SIZE INS (MM)	FINISH	PAIRS PER BOX	CODE
7" x 2" (175x50)	Dull Black	5	556 175 3

Suitable for up to 3" thick doors or gates. Recommended for use with Mortise Sash Lock below. For thicker applications, use Extension Spindle, page 35.

# ANTIQU IRONMONGERY

MORTISE SASH LOCK				
SIZE INS (MM)	FINISH	QTY PER BOX	CODE	
2 1/2" (65)	Satin	5	149 002 0	INDOOR USE
2 1/2" (65)	Satin	5	149 002 0HD	OUTDOOR USE

Reversible for LH or RH doors. Recommended for use with Lever Lock Handles above.  
See other lock sets on page 47.



ANTIQU STRAIGHT DOOR BOLTS				
SIZE INS (MM)	FINISH	QTY PER BOX	CODE	
6" (150)	Dull Black	5	557 150 3	
8" (200)	Dull Black	5	557 200 3	



ANTIQU CABIN HOOKS				
SIZE INS (MM)	FINISH	QTY PER BOX	CODE	
4" (100)	Dull Black	5	559 100 3	
6" (150)	Dull Black	5	559 150 3	



ANTIQU DOOR HANDLE F.D.L.				
SIZE INS (MM)	FINISH	QTY PER BOX	CODE	
4" (100)	Dull Black	5	560 100 3	
6" (150)	Dull Black	5	560 150 3	
10" (250)	Dull Black	5	560 250 3	



ANTIQU RING GATE LATCH				
SIZE INS (MM)	FINISH	QTY PER BOX	CODE	
8" (200)	Dull Black	5	561 200 3	

Suitable for up to 4" thick doors or gates  
For thicker applications, use Extension Spindle, see below  
Comes with [PADLOCK EYES](#)



ANTIQU RING HANDLE ONLY				
SIZE INS (MM)	FINISH	QTY PER BOX	CODE	
4" (100)	Dull Black	5	561 200 3 A	



EXTENSION SPINDLE				
SIZE INS (MM)	FINISH	QTY PER BOX	CODE	
5 3/8" (130)	Zinc	5	561 130 2	

For use with all ring gate latches: 5612003, 5251553, 5241503, 5551503, 5561753



# ANTIQUE IRONMONGERY



## ANTIQUE SUFFOLK LATCH

SIZE INS (MM)	FINISH	QTY PER BOX	CODE
6" (150)	Dull Black	5	564 150 3

Suitable for up to 2 1/4" thick doors or gates  
Can be used with padlock eyes, page 47.

## ANTIQUE HEAVY SUFFOLK LATCH

SIZE INS (MM)	FINISH	QTY PER BOX	CODE
10" (250)	Dull Black	5	564 250 3

Suitable for up to 4" thick doors or gates  
Can be used with padlock eyes, page 47.



## ANTIQUE SUFFOLK HANDLE ONLY

SIZE INS (MM)	FINISH	QTY PER BOX	CODE
6" (150)	Black	5	564 150 3A
10" (250)	Black	5	564 250 3A

BRASS



## ANTIQUE NAUTICAL DINNER BELL

SIZE INS (MM)	FINISH	QTY PER BOX	CODE
5" (125)	Black	1	577 125 3



## ANTIQUE HEAVY DOOR PULL

SIZE INS (MM)	FINISH	QTY PER BOX	CODE
10" (250)	Dull Black	5	568 250 3



## ANTIQUE MISSION DOOR PULL

SIZE INS (MM)	FINISH	QTY PER BOX	CODE
14" (350)	Black	5	568 350 3



## ANTIQUE MISSION DOOR GRILL

SIZE INS (MM)	FINISH	QTY PER BOX	CODE
12" (300)	Dull Black	1	575 303 3

# ANTIQUE IRONMONGERY

## ANTIQUE 0-9 NUMERICALS

SIZE INS (MM)	FINISH	QTY PER BOX	CODE
7" (175)	Dull Black	5	570 175 0-9

7" **0123456789**

7" MEETS NEW SIZE REQUIREMENTS  
FOR EMERGENCY RESPONSE

## ANTIQUE DROP ROD

SIZE INS (MM)	FINISH	QTY PER BOX	CODE
24 x 5/8"	Dull Black	5	518 600 3



## WILLIAMSBURG GRAVITY GATE CLOSER

SIZE INS (MM)	FINISH	QTY PER BOX	CODE
3 3/4" (95)	Dull Black	5	577 095 3



## ANTIQUE DOOR STUDS

SIZE INS (MM)	FINISH	QTY PER PACK	PACKAGED CODE	BULK CODE
3/4" (19)	Dull Black	10	562 019 3	162 019 3
1 1/8" (32)	Dull Black	10	562 032 3	162 032 3
1 1/2" (37)	Dull Black	5	562 037 3	162 037 3



## ANTIQUE CLAVOS

SIZE INS (MM)	FINISH	QTY PER PACK	PACKAGED CODE	BULK CODE
1 1/8" (25)	Black	10	562 025 9	162 025 9
1 1/2" (37)	Black	5	562 037 9	162 037 9

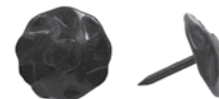

## GATEMATE GATE SIGNS

DESCRIPTION	SIZE MM	FINISH	QTY PER BOX	CODE
Please shut the gate	160 x 55mm	Brass	5	544 000 5
Please shut the gate	160 x 55mm	Chrome	5	544 000 C
Beware of the dog	160 x 55mm	Brass	5	544 001 5
Beware of the dog	160 x 55mm	Chrome	5	544 001 C



**NOW STOCKING!**

# **ALUMINUM PRIVACY PANELS & GATES**

Great When Fire Resistant Applications are Required

[Ask for details](#)

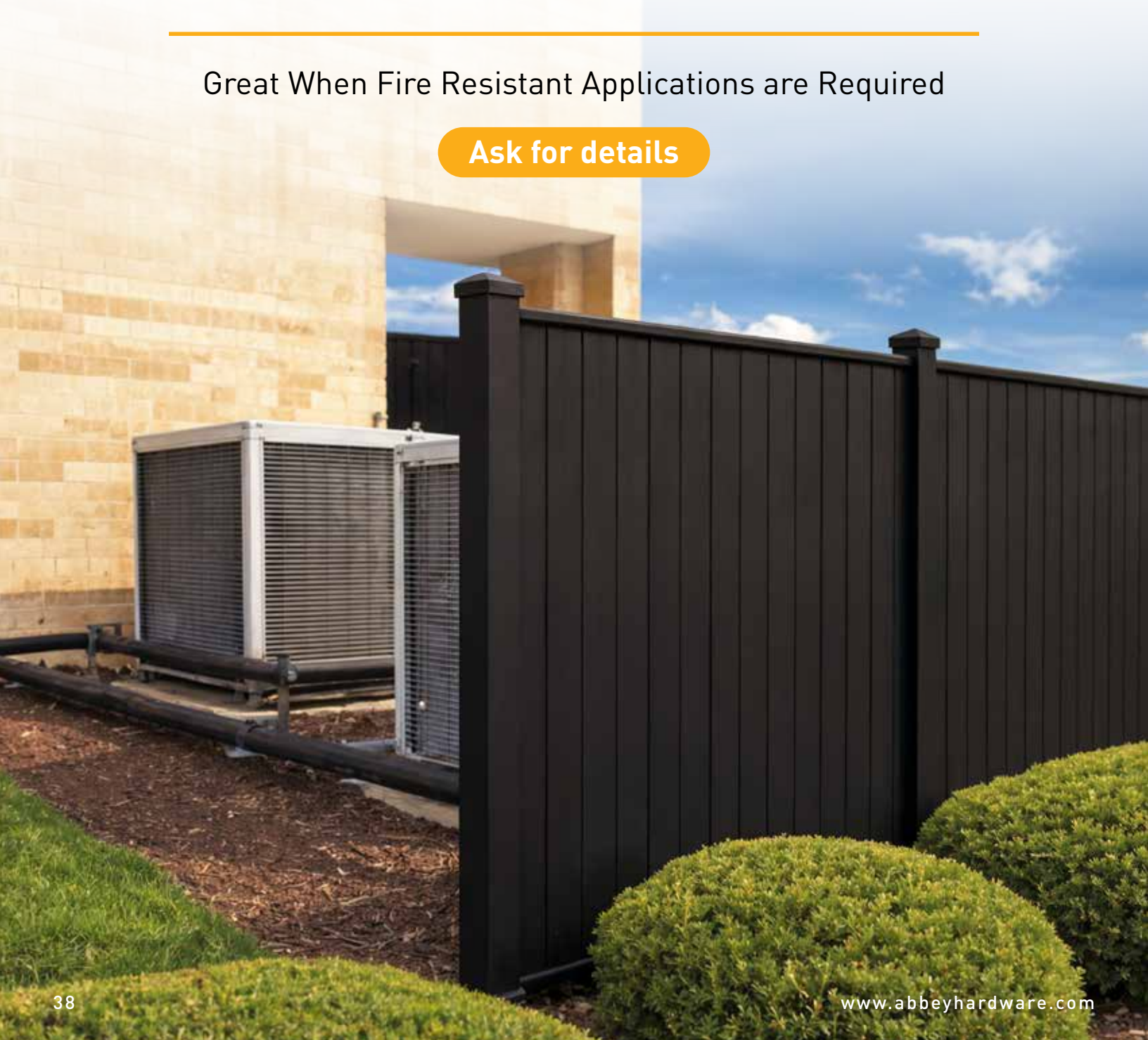



# STAINLESS STEEL HARDWARE

Try out our line of 316 marine grade stainless steel gate hardware. It is available in brushed S/S and comes with stainless steel fasteners. Ideal for coastal areas. Long lasting for any application.



# STAINLESS STEEL HARDWARE



## STRONG TEE HINGE

SIZE INS	FINISH	QTY PER BOX	CODE
12"	316 SS Brushed Matte	1 PAIR	505 3006



## CRANKED BANDS AND HOOKS

SIZE INS	FINISH	QTY PER BOX	CODE
18"	316 SS Brushed Matte	1 PAIR	507 4506
24"	316 SS Brushed Matte	1 PAIR	507 6006



## ADJUSTABLE BANDS AND HOOKS

SIZE INS	FINISH	QTY PER BOX	CODE
18"	316 SS Brushed Matte	1 PAIR	508 4506
24"	316 SS Brushed Matte	1 PAIR	508 6006

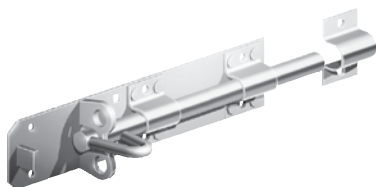

## BRENTON PADBOLTS 1/2" SHOOT

SIZE INS	FINISH	QTY PER BOX	CODE
6 x 1/2"	316 SS Brushed Matte	1	512 1506

Padlockable

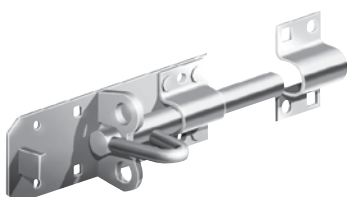

## BRENTON PADBOLTS 5/8" SHOOT

SIZE INS	FINISH	QTY PER BOX	CODE
8 x 5/8"	316 SS Brushed Matte	1	513 2006

Padlockable

# STAINLESS STEEL HARDWARE

## CRAFTSMAN RING GATE LATCH

SIZE INS (MM)	FINISH	QTY PER BOX	CODE
6" (150)	316 SS Brushed Matte	1	525 1556

Comes with PADLOCK EYES. Self-latching.  
Suitable for up to 3" thick doors or gates.  
For thicker applications, use Extension Spindle, page 35.

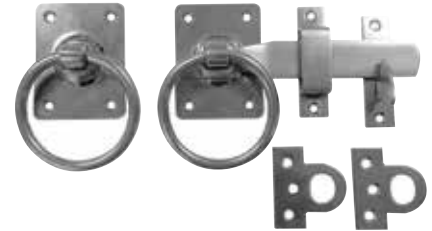

## CRAFTSMAN RING HANDLE

SIZE INS (MM)	FINISH	QTY PER BOX	CODE
3 1/2" (87)	316 SS Brushed Matte	1	525 1556A



## HEAVY WINDSOR LATCH

SIZE	FINISH	QTY PER BOX	CODE
HEAVY	316 SS Brushed Matte	1	523 0036

Suitable for up to 3" thick doors or gates. Self-latching.

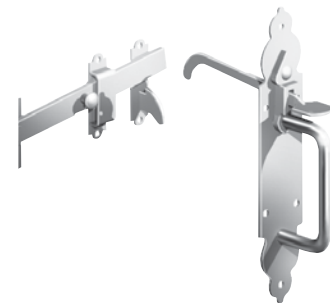

## HEAVY LOCKING GARAGE DOOR BOLTS

SIZE INS	FINISH	QTY PER BOX	CODE
18 x 5/8"	316 SS Brushed Matte	1	517 4506

Padlockable



## CABIN HOOK

SIZE INS	FINISH	QTY PER BOX	CODE
4"	316 SS Brushed Matte	1	541 1006



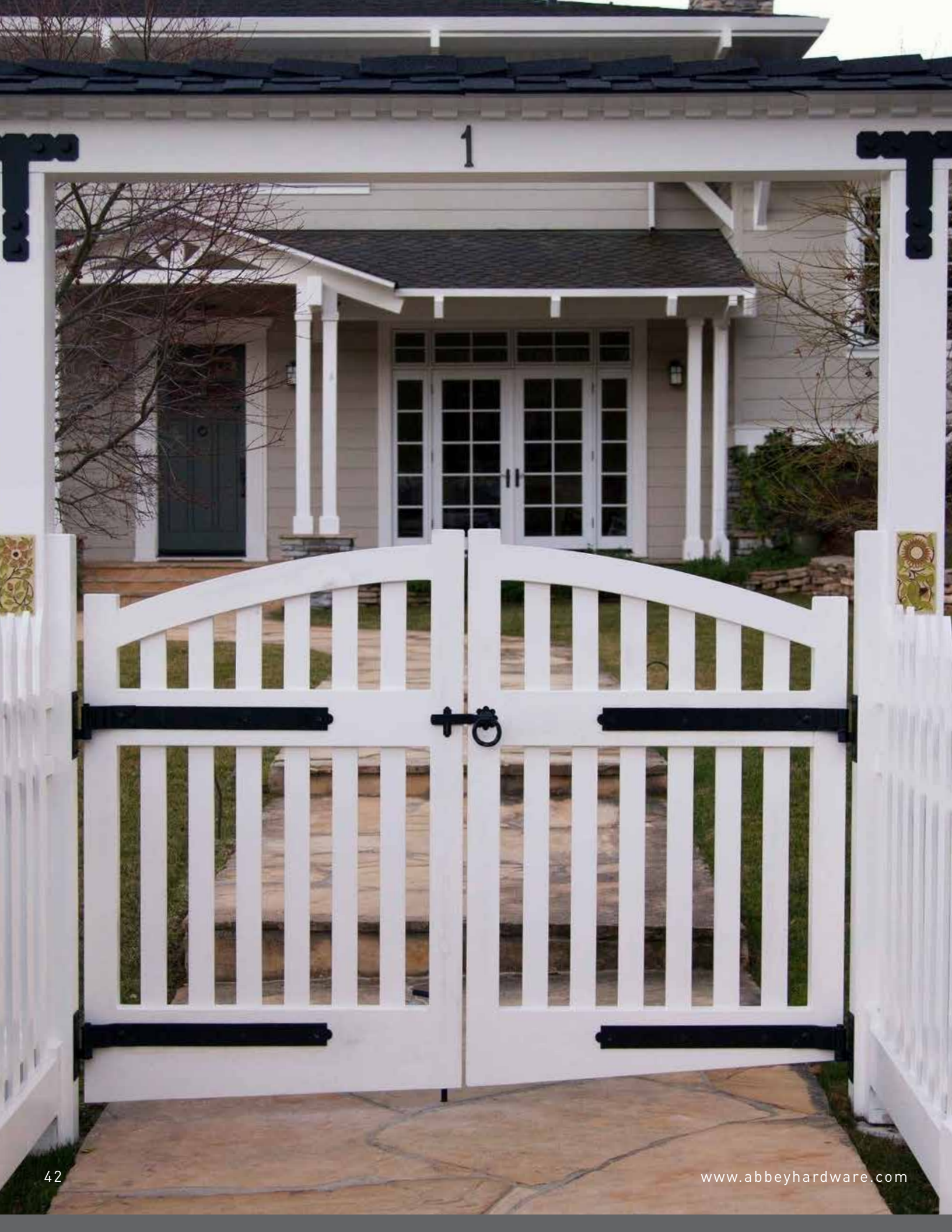

1



# SECURITY PRODUCTS

Unique locking hardware for a variety of security applications including custom gates and doors.



## 2 EASY STEPS TO FIND THE LOCK HANDING

For some of our locks, we offer a right-handed or a left-handed version and the lock handing you choose depends on whether your gate is right or left-hand hung.

### IMPORTANT-Read Before Purchasing a Lock!

#### LEFT HANDED LOCK

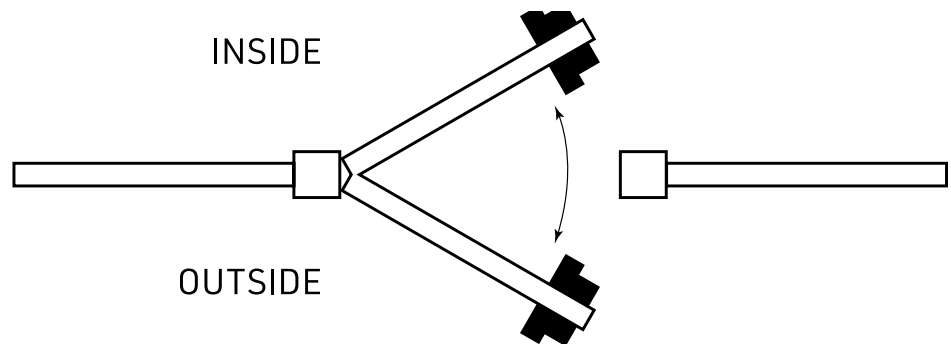

#### RIGHT HANDED LOCK

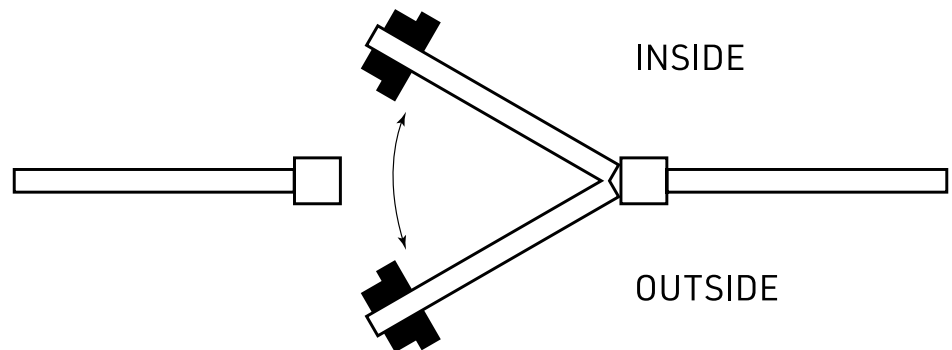

**Step 1:** Look at your gate from the outside (secure side) or visualize it if the gate is yet to be installed.

**Step 2:** The side that your hinges are on equals the lock handing. For example, if your gate hinges are on the right, you will need a right-hand lock (and vice versa).

# SECURITY PRODUCTS

EASY INSTALL -  
NO ELECTRICAL OR  
BATTERIES NECESSARY

**ABBHEY**  
GATEPRO

All Fasteners Included



## SURFACE MOUNT LOCKS (NO MORTICING REQUIRED)

### LOCKING BOLT STAINLESS STEEL LONG THROW

THICKNESS	FINISH	CODE
Up to 24 mm = 1 5/16	Silver	GLB
Up to 60 mm = 2 3/8	Silver	GLB02
Up to 24 mm = 1 5/16	Black	GLBB
Up to 60 mm = 2 2/8	Black	GLBB02



Comes with 3 keys. Mounts on the inside of gate. Can be used with RH or LH gates. Keyed alike available. Screw fixed lock for gates.

### SELECTPRO QUICK EXIT DIGITAL GATE LOCK

DESCRIPTION	GATE THICKNESS	CODE
Left Handed	3 1/2"	SBQEDGLWL
Right Handed	3 1/2"	SBQEDGLWR



Quick exit on one side and digital keypad on the other. Striker plate for post included. Self Latching.

## SURFACE MOUNT GATE LOCKS (NO MORTICING REQUIRED)



### SELECTPRO DIGITAL GATE LOCK - DOUBLE SIDED

DESCRIPTION	GATE THICKNESS	CODE
Left Hand	up to 3 1/2"	DGLWL
Right Hand	up to 3 1/2"	DGLWR

Keypad on both entry and exit side. Keep included. Self Latching.  
Installation videos available at [www.abbeyhardware.com](http://www.abbeyhardware.com).  
For thicker gate use Extension Bolts on page 55.



### SELECTPRO DIGITAL GATE LOCK - SINGLE SIDED

DESCRIPTION	GATE THICKNESS	CODE
Left Hand	up to 3 1/2"	DGLSWL
Right Hand	up to 3 1/2"	DGLSWR

Keypad on entry side and handle on exit side. Keep included. Self Latching.  
Installation videos available at [www.abbeyhardware.com](http://www.abbeyhardware.com).  
For thicker gate use Extension Bolts on page 55.



### SUPERLATCH DIGITAL GATE LOCK - SINGLE SIDED

DESCRIPTION	GATE THICKNESS	CODE
Inswing only	up to 2 3/4"	SLDS

Excellent, low cost alternative to a standard digital keypad for wooden gates.  
Reversible handing - can be used on left or right handed gates. Inswing only.  
Surface fixed. Self Latching.



### SUPERLATCH RAPID RESET DIGITAL GATE LOCK - SINGLE SIDED

DESCRIPTION	GATE THICKNESS	CODE
Inswing only	3"	SLDSRR

Excellent low cost alternative to a standard digital keypad. Reversible handing - can be used on left or right handed gates. No hassle code reset. With handle on one side. Self Latching. Inswing Only!

## SURFACE MOUNT GATE LOCKS (NO MORTICING REQUIRED)

### SUPERLOCK DIGITAL - DOUBLE SIDED

DESCRIPTION	GATE THICKNESS	CODE
Left Handed	up to 3"	BDGWL
Right Handed	up to 3"	BDGWR

Keypad on entry and exit. Keep included.  
Suitable for wooden, vinyl and metal gates. Extension available for thicker gates.  
Self Latching.



### SUPERLOCK DIGITAL - SINGLE SIDED

DESCRIPTION	GATE THICKNESS	CODE
Left Handed	up to 3"	BDGSWL
Right Handed	up to 3"	BDGSWR

Keypad on entry and rear handle on exit. Keep included.  
Suitable for wooden, vinyl and metal gates. Extension available for thicker gates.  
Self Latching.



### SUPERLOCK RAPID RESET DIGITAL - DOUBLE SIDED

DESCRIPTION	GATE THICKNESS	CODE
Left Handed	upto 3"	BDGWRRLL
Right Handed	upto 3"	BDGWRRR

A compact and reliable digital lock with Handle Included. Striker Plate for Post Included. No Hassle Code Reset. Self Latching.



### SUPERLOCK RAPID RESET DIGITAL - SINGLE SIDED

DESCRIPTION	GATE THICKNESS	CODE
Left Handed	upto 3"	BDGSWRRLL
Right Handed	upto 3"	BDGSWRRR

A compact and reliable digital lock with Handle Included. Striker Plate for Post Included. No Hassle Code Reset. Self Latching.



### SURFACE MOUNT LOCKS (NO MORTICING REQUIRED)



SLIDE ACTION / SINGLE-SIDED WITH BUTTON ON ONE SIDE

#### RIM LOCK - LONG THROW

TYPE	THROW LENGTH	KEY CYL. LENGTH	FINISH	QTY PER BOX	CODE
Double Cylinder (B)	2 1/2" (60)	2" (50)	Stainless/Black	1/20	149 018 6
Double Cylinder (B)	2 1/2" (60)	2 3/4" (70)	Stainless/Black	1/20	149 019 6
Single Cylinder (A)	2 1/2" (60)	2" (50)	Stainless/Black	1/20	149 110 6
Single Cylinder (A)	2 1/2" (60)	2 3/4" (70)	Stainless/Black	1/20	149 111 6



DOUBLE-SIDED / KEYED ON BOTH SIDES

#### RIM LOCK - LONG THROW (KEYED ALIKE)

TYPE	THROW LENGTH	KEY CYL. LENGTH	FINISH	QTY PER BOX	CODE
Double Cylinder (B)	2 1/2" (60)	2" (50)	Stainless/Black	1/20	149 112 6
Double Cylinder (B)	2 1/2" (60)	2 3/4" (70)	Stainless/Black	1/20	149 113 6
Single Cylinder (A)	2 1/2" (60)	2" (50)	Stainless/Black	1/20	149 114 6
Single Cylinder (A)	2 1/2" (60)	2 3/4" (70)	Stainless/Black	1/20	149 115 6

Ideal Security for Gates / Easy to install. For wood gates. Comes with 5 keys. #1490000 - spare keys. Installation videos available at [www.abbeyhardware.com](http://www.abbeyhardware.com). Can be used for LH or RH gates/doors.



#### RIM LOCK HANDLE

SIZE INS (MM)	FINISH	QTY PER BOX	CODE
8" (200)	Black	1/5	147 2003 RLH

For use with Long Throw Locks.

### BOLT-ON LOCKS



#### SUPERLOCK KEYED DEADBOLT GATE LOCK - DOUBLE SIDED

DESCRIPTION	GATE THICKNESS	CODE
Left or Right Handed	10-30mm = 3/8"-1-1/8"	BLD1030P
Left or Right Handed	40-60mm = 1-1/2"-2-3/8"	BLD4060P

Adjustable and secure stainless steel gate lock with double-sided keyed access. Handle Included. Self Latching. Turn the key again for deadbolt.



#### SELECTPRO DIGITAL GATE LOCK - SINGLE SIDED

DESCRIPTION	GATE THICKNESS	CODE
Left Handed	10-30mm = 3/8"-1-1/8"	DGLS01L
Right Handed	10-30mm = 3/8"-1-1/8"	DGLS01R
Left Handed	40-60mm = 1-1/2"-2-3/8"	DGLS02L
Right Handed	40-60mm = 1-1/2"-2-3/8"	DGLS02R

Compact reliable gatelock with digital keypad on one side, knob on other. Striker plate included. Self Latching.

## BOLT-ON LOCKS

### SELECTPRO DIGITAL GATE LOCK-DOUBLE SIDED

DESCRIPTION	GATE THICKNESS	CODE
Left or Right Handed	10-30mm = 3/8" - 1-1/8"	DGL01
Left or Right Handed	40-60mm = 1-1/2" - 2-3/8"	DGL02

Adjustable and secure stainless steel gate lock with double-sided keyed access. Handle Included. Self Latching.



### SELECTPRO GATE LOCK QUICK EXIT - KEYED

DESCRIPTION	GATE THICKNESS	CODE
Left Handed, Bolt-on	10 - 30mm = 3/8" - 1 1/4"	SBQEKL01
Right Handed, Bolt-on	10 - 30mm = 3/8" - 1 1/4"	SBQEKL01
Left Handed, Bolt-on	40 - 60mm = 1 1/2" - 2 1/2"	SBQEKL02
Right Handed, Bolt-on	40 - 60mm = 1 1/2" - 2 1/2"	SBQEKL02

Quick exit on one side and keyed on the other.  
Striker plate for post included. For flat bar and tube gates.  
Self Latching. Can be used with shrouds, page 52.



### SELECTPRO DIGITAL GATE LOCK QUICK EXIT

DESCRIPTION	GATE THICKNESS	CODE
Left Handed, Bolt-on with keypad	10 - 30mm = 3/8" - 1 1/4"	SBQEDGL01
Right Handed, Bolt-on with keypad	10 - 30mm = 3/8" - 1 1/4"	SBQEDGL01
Left Handed, Bolt-on with keypad	40 - 60mm = 1 1/2" - 2 1/2"	SBQEDGL02
Right Handed, Bolt-on with keypad	40 - 60mm = 1 1/2" - 2 1/2"	SBQEDGL02

Quick exit on one side and digital keypad on the other.  
Striker plate for post included. For flat bar and tube gates.  
Self Latching. Can be used with shrouds, page 52.



### SUPERLOCK KEYED QUICK EXIT

DESCRIPTION	GATE THICKNESS	CODE
Left Handed, Key on Outside	10-30 mm = 3/8" - 1 1/4"	BQK1030L
Right Handed, Key on Outside	10-30 mm = 3/8" - 1 1/4"	BQK1030R
Left Handed, Key on Outside	40-60 mm = 1 1/2" - 2 1/2"	BQK4060L
Right Handed, Key on Outside	40-60 mm = 1 1/2" - 2 1/2"	BQK4060R

Quick exit on one side and keyed on the other.  
Striker plate for post included. For flat bar and tube gates.  
Self Latching. Can be used with shrouds, page 52.



## BOLT-ON LOCKS



### SUPERLOCK DIGITAL QUICK EXIT

DESCRIPTION	GATE THICKNESS	CODE
Left Handed, Keypad on Outside	10 - 30mm = 3/8" - 1 1/4"	BQDG1030L
Right Handed, Keypad on Outside	10 - 30mm = 3/8" - 1 1/4"	BQDG1030R
Left Handed, Keypad on Outside	40 - 60mm = 1 1/2" - 2 1/2"	BQDG4060L
Right Handed, Keypad on Outside	40 - 60mm = 1 1/2" - 2 1/2"	BQDG4060R

Quick exit on one side and keyed on the other.  
Striker plate for post included. For flat bar and tube gates.  
Self Latching. Can be used with shrouds, page 52.



### SUPERLOCK RAPID RESET DIGITAL QUICK EXIT

DESCRIPTION	GATE THICKNESS	CODE
Left Handed	10-30mm = 3/8"-1-1/8"	BQDGRR1030L
Right Handed	10-30mm = 3/8"-1-1/8"	BQDGRR1030R
Left Handed	40-60mm = 1-1/2"-2-3/8"	BQDGRR4060L
Right Handed	40-60mm = 1-1/2"-2-3/8"	BQDGRR4060R

Quick exit on one side and digital keypad on the other. A compact and reliable digital lock with Handle Included. Striker Plate for Post Included. For Flat Bar and Tube Gates. No Hassle Code Reset. Self Latching. Can be used with shrouds, page 52.



### SUPERLOCK DIGITAL - SINGLE SIDED

DESCRIPTION	GATE THICKNESS	CODE
Left Handed	10-30 mm - 3/8" - 1 1/4"	BDGS1030L
Right Handed	10-30 mm - 3/8" - 1 1/4"	BDGS1030R
Left Handed	40-60 mm - 1 1/2" - 2 1/2"	BDGS4060L
Right Handed	40-60 mm - 1 1/2" - 2 1/2"	BDGS4060R

A compact digital gate lock with a single inside knob.  
Striker plate for post included. For flat bar and tube gates.  
Self Latching.



### SUPERLOCK DIGITAL - DOUBLE SIDED

DESCRIPTION	GATE THICKNESS	CODE
Left Handed	10-30 mm - 3/8" - 1 1/4"	BDG1030L
Right Handed	10-30 mm - 3/8" - 1 1/4"	BDG1030R
Left Handed	40-60 mm - 1 1/2" - 2 1/2"	BDG4060L
Right Handed	40-60 mm - 1 1/2" - 2 1/2"	BDG4060R

A compact digital gate lock with a single inside knob.  
Striker plate for post included. For flat bar and tube gates.  
Self Latching.

### BOLT-ON LOCKS

#### SUPERLOCK DIGITAL WITH DELTA LEVER HANDLE - DOUBLE SIDED

DESCRIPTION	GATE THICKNESS	CODE
Left Handed	10-30mm =3/8"-1-1/8"	BDGDL1030L
Right Handed	10-30mm =3/8"-1-1/8"	BDGDL1030R
Left Handed	40-60mm =1-1/2"-2-3/8"	BDGDL4060L
Right Handed	40-60mm =1-1/2"-2-3/8"	BDGDL4060R

A compact and reliable digital lock with Handle Included. Striker Plate for Post Included. For Flat Bar and Tube Gates. Self Latching.



#### SUPERLOCK DIGITAL WITH DELTA LEVER HANDLES - SINGLE SIDED

DESCRIPTION	GATE THICKNESS	CODE
Left Handed	10-30mm =3/8"-1-1/8"	BDGDSL1030L
Right Handed	10-30mm =3/8"-1-1/8"	BDGDSL1030R
Left Handed	40-60mm =1-1/2"-2-3/8"	BDGDSL4060L
Right Handed	40-60mm =1-1/2"-2-3/8"	BDGDSL4060R

A compact and reliable digital lock with Handle Included. Striker Plate for Post Included. For Flat Bar and Tube Gates. Self Latching.



#### SUPERLOCK RAPID RESET DIGITAL - DOUBLE SIDED

DESCRIPTION	GATE THICKNESS	CODE
Left Handed	10-30mm =3/8"-1-1/8"	BDGRR1030L
Right Handed	10-30mm =3/8"-1-1/8"	BDGRR1030R
Left Handed	40-60mm =1-1/2"-2-3/8"	BDGRR4060L
Right Handed	40-60mm =1-1/2"-2-3/8"	BDGRR4060R

A compact and reliable digital lock with Handle Included. Striker Plate for Post Included. For Flat Bar and Tube Gates. Self Latching.



#### SUPERLOCK RAPID RESET DIGITAL - SINGLE SIDED

DESCRIPTION	GATE THICKNESS	CODE
Left Handed	10-30mm =3/8"-1-1/8"	BDGSRR1030L
Right Handed	10-30mm =3/8"-1-1/8"	BDGSRR1030R
Left Handed	40-60mm =1-1/2"-2-3/8"	BDGSRR4060L
Right Handed	40-60mm =1-1/2"-2-3/8"	BDGSRR4060R

A compact and reliable digital lock with Handle Included. Striker Plate for Post Included. For Flat Bar and Tube Gates. Self Latching.



## BOLT-ON LOCKS



### SUPERLOCK RAPID RESET DIGITAL SLIDING LOCK- DOUBLE SIDED

DESCRIPTION	GATE THICKNESS	CODE
Left Handed	40mm (1 9/16") gate frame	SGLDRR40L
Right Handed	40mm (1 9/16") gate frame	SGLDRR40R
Left Handed	50mm (2") gate frame	SGLDRR50L
Right Handed	50mm (2") gate frame	SGLDRR50R
Left Handed	60mm (2 3/8") gate frame	SGLDRR60L
Right Handed	60mm (2 3/8") gate frame	SGLDRR60R

A compact and reliable digital lock with Handle Included. Striker Plate for Post Included. For Flat Bar and Tube Gates. No Hassle Code Reset. For sliding gates. Self Latching.

## ACCESSORIES & PARTS



### SHROUD FOR SUPERLOCK QUICK EXIT LOCKS

DESCRIPTION	CODE
Deters intruders reaching to operate from the outside	BQS

For use with superlock quick exit & superlock single sided locks. Max security when used in conjunction with fill material. For flat bar and tube gates.



### SHROUD FOR SELECT PRO QUICK EXIT LOCKS

DESCRIPTION	CODE
Deters Intruders reaching to operate from the outside	SBQES

For use with SelectPro Quick exit & SelectPro single sided locks. Max security when used in conjunction with fill material. For flat bar and tube gates.



### SUPERLOCK SHROUD, LEVER HANDLE LOCKS (RAPIDRESET)

DESCRIPTION	CODE
Use with Right Hand Lock	BQSLR
Use with Left Hand Lock	BQSLL
Deters intruders reaching to operate from the outside.	

## SECURITY KEEP FOR SUPERLOCK

DESCRIPTION	CODE
Bolts onto the gate and post when fitting the Superlock	BSK

For use with flat bar and tube gates.  
Not compatible with surface fixed locks.



## SECURITY KEEP FOR SUPERLOCK WITH INTERLOCKING TAB

DESCRIPTION	CODE
Bolts onto the gate and post when fitting the lock	BSKS

For use with flat bar and tube Superlock range.  
Not compatible with surface fixed locks.



## SUPERLOCK GAPLESS KEEP

DESCRIPTION	CODE
Fits between gate and post to enable small gap	BSKG

For metal tube gates. Works with all bolt on locks.  
Anti-Clang.



## GATE SILENCER KIT

DESCRIPTION	CODE
Bracket to eliminate slamming Noise	GSK



## HYDRAULIC GATE CLOSER WITH STOP HINGE - WELD

DESCRIPTION	CODE
Hydraulic gate closer with stop hinge to weld on	APSSTOP

Stops at 90°. Controlled close.  
Suitable for pedestrian gates.





### HYDRAULIC GATE CLOSER WITH STOP HINGE - BOLT

DESCRIPTION	CODE
Hydraulic gate closer with stop hinge to bolt on	APSW

Controlled Close. Bolt on.  
Suitable for pedestrian gates.



### GAS-SPRING CLOSER - WELD

DESCRIPTION	CODE
Gas-spring closer with brackets to weld on	GSB



### GAS-SPRING CLOSER - BOLT

DESCRIPTION	CODE
Gas-spring closer with brackets to bolt on	GSBW



### SECURITY SUPERHINGE ADJUSTABLE

WEIGHT	SIZE	CODE
330 lbs per pair	5/8"x4"	SH16
660 lbs per pair	3/4"x6"	SH20
990 lbs per pair	1"x6"	SH25
1980 lbs per pair	1-1/8"x6"	SH30

Security hinge with break-off nut to prevent tampering. Brass Bearings.  
20 year guarantee.



### BRASS PADLOCKS

SIZE INS (MM)	FINISH	CODE
1 1/4" (30)	Chrome Shackle	539 030 0
1 1/2" (40)	Chrome Shackle	539 038 0
2" (50)	Chrome Shackle	539 050 0
2 1/2" (65)	Chrome Shackle	539 005 0

Includes 3 keys.

# SECURITY PRODUCTS

All Fasteners Included

PADLOCK EYES		
SIZE INS	FINISH	CODE
2 1/8"	Black	149 051 0

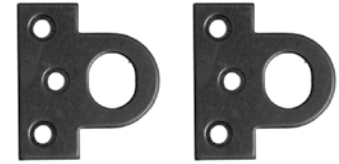

LOCKING DROP BOLT		
FINISH	SIZE	CODE
Aluminum	18" x 3/4"	LDB
Stainless Steel	18" x 3/4"	LDBSS



GATE RESTRAINER/ GATE TETHER		
OPERATIONAL LENGTH	WEIGHT	CODE
8.75"*	485LBS*	GRS-03
10.75"*	1100LBS*	GRS-04



\*Based on a maximum gate width of 2.5m = Approx. 8ft.

ROUND BAR ADAPTER - LOCK AND GATE POST KIT	
DESCRIPTION	Code
Adapter for Chain Link	RBAK
For Superlocks, not SelectPro	

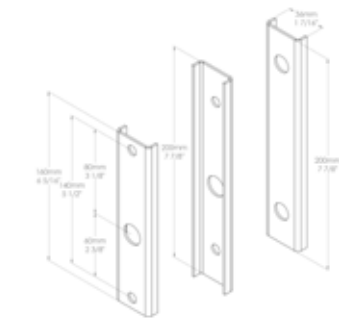

EXTENSION KIT		
Operational Length	Size	Code
7" Spindle (A)	Zinc	DGL021
M5 X 120mm (4 5/8) Bolt (B)	Black	DGLEXTMS128



Use with surface fixed locks.

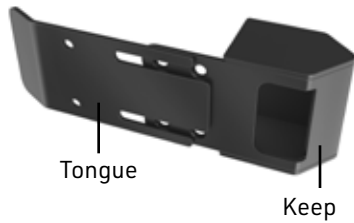

### TONGUE & KEEP (MOUNTS ON THE POST)

DESCRIPTION	FINISH	CODE
For outswing Surface Fixed Locks	Black	DGL054
For all Types	Black	DGL054-Keep



### LATCH BOLT

Operational Length	Finish	Code
10-30mm = 3/8" - 1-1/8"	SS	PH371030
40-60mm = 1-1/2" - 2-3/8"	SS	PH374060
100-120mm = 4" - 4-3/4"	SS	DRA0181602L

Use with Bolt-on Locks





# SHED & BARN HARDWARE

The following pages contain a selection of hardware ranging from Simple to Elegant to suit the whole range of Basic Storage Sheds to Superior Barns.



# SHED & BARN HARDWARE

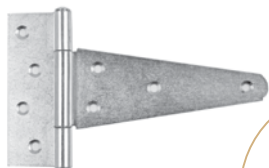

Pre-packed  
With Fasteners

## STANDARD TEE HINGES

SIZE INS (MM)	FINISH	QTY PER BOX	BULK CODE	QTY PER BOX	PRE-PACKED CODE
4" (100)	Galvanized	10/100	004 100 1	10/100	050 100 1
4" (100)	Zinc	10/100	004 100 2	10/100	050 100 2
4" (100)	Super Black	10/100	004 100 3	10/100	050 100 3
6" (150)	Galvanized	10/60	004 150 1	5/30	050 150 1
6" (150)	Zinc	10/60	004 150 2	5/30	050 150 2
6" (150)	Super Black	10/60	004 150 3	5/30	050 150 3

Galvanized hinges have brass pins. See more sizes on page 2.



## ESTATE TEE HINGES

DESCRIPTION	SIZE INS (MM)	FINISH	QTY PER BOX	CODE
Spring loaded	8" (200)	Black	20	004 222 3
Removable pin	8" (200)	Black	20	004 201 3
Fixed pin	8" (200)	Black	20	004 203 3

Includes fasteners



## DECORATIVE TEE HINGE WITH BUSHINGS

SIZE INS (MM)	FINISH	QTY PER BOX	CODE
5" (125)	Black	10/100	004 125 3
6" (150)	Black	10/100	004 150 3D



## INSIDE DOOR HANDLE

SIZE INS (MM)	FINISH	QTY PER BOX	CODE
3 3/4" (94)	Black	100	802 094 3
3 3/4" (94)	Chrome	100	802 094 4

Use with Locking T-Handles or Locking L-Handles.



## STEEL DOOR PULL (BAR HOLDER)

SIZE INS (MM)	FINISH	QTY PER BOX	CODE
6 1/2" (165)	Zinc	10/60	191 150 2

# SHED & BARN HARDWARE

## LOCKING L-HANDLES

SIZE INS (MM)	FITS DOOR SIZE	FINISH	QTY PER BOX	CODE
2 1/2" (62)	1/2" - 1 1/2"	Chrome	50	801 062 4
3" (75)	1/2" - 2"	Chrome	50	801 075 4
3 1/2" (89)	1-2 1/2"	Chrome	50	801 089 4
3 1/2" (89)	1-2 1/2"	Black	50	801 089 3
4 1/2" (112)	2 3/4-3 3/4"	Chrome	50	801 112 4
4 1/2" (112)	2 3/4-3 3/4"	Black	50	801 112 3
5 1/2" (137)	3 3/4-4 3/4"	Chrome	50	801 137 4
5 1/2" (137)	3 3/4-4 3/4"	Black	50	801 137 3



Keyed differently. Keyed alike available. Master key available. Includes 1 keyset, Spare Keysets available. Does not include inside door handle.

## LOCKING T-HANDLES

SIZE INS (MM)	FITS DOOR SIZE	FINISH	QTY PER BOX	CODE
3 1/2" (89)	1-2 1/2"	Chrome	50	800 089 4
3 1/2" (89)	1-2 1/2"	Black	50	800 089 3
4" (100)	1 3/4-2 3/4"	Chrome	50	800 100 4
4" (100)	1 3/4-2 3/4"	Black	50	800 100 3
4 1/2" (112)	2 3/4-3 3/4"	Chrome	50	800 112 4
4 1/2" (112)	2 3/4-3 3/4"	Black	50	800 112 3
5 1/2" (137)	3 3/4-4 3/4"	Chrome	50	800 137 4
5 1/2" (137)	3 3/4-4 3/4"	Black	50	800 137 3
6" (150)	4 3/4-5 3/4"	Chrome	50	800 150 4
6" (150)	4 3/4-5 3/4"	Black	50	800 150 3
6 3/4" (172)	5 3/4-6 3/4"	Chrome	50	800 162 4
6 3/4" (172)	5 3/4-6 3/4"	Black	50	800 162 3



Keyed differently. Keyed alike available. Master key available. Includes 1 keyset, Spare Keysets available. Does not include inside door handle.

## SLIDE BOLTS

SIZE INS (MM)	FINISH	QTY PER BOX	CODE
6" (150)	Galvanized	10/80	602 002 1
6" (150)	Zinc	10/80	602 002 2
6" (150)	Black	10/80	602 002 3



Includes fasteners

# SHED & BARN HARDWARE

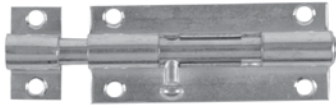

## BARREL BOLTS

SIZE INS (MM)	FINISH	QTY PER BOX	CODE
4" (100)	Galvanized	10/100	602 100 1
4" (100)	Zinc	10/100	602 100 2
4" (100)	Black	10/100	602 100 3

Fasteners included



## LOOP STYLE BARREL BOLT, SPRING LOADED LONG PIN

SIZE INS (MM)	FINISH	QTY PER BOX	CODE
4" (100)	YL Zinc	10/60	110 075 2



## SPRING LOADED BOLTS - SHORT BODY *Glow in the dark handle!*

SHOOT DIA INS (MM)	LENGTH INS (MM)	FINISH	QTY PER BOX	CODE
3/8" (9.5)	2 1/2" (60)	Zinc	10	110 395 2
1/2" (12)	3" (75)	Zinc	10	110 312 2



## CHAIN BOLTS 5/8" SHOOT

SIZE INS (MM)	FINISH	QTY PER BOX	CODE
6" (150)	Zinc	10	517 150 2
8" (200)	Zinc	5	517 200 2
8" (200)	Black	5	517 200 3

Fasteners included



## FOOT BOLTS

SIZE INS (MM)	FINISH	QTY PER BOX	CODE
8" (200)	Zinc	5	518 200 2
8" (200)	Black	5	518 200 3

Fasteners included



## AUTO LATCH

SIZE INS (MM)	FINISH	QTY PER BOX	CODE
2" (50)	Galvanized	10/100	601 001 1
2" (50)	Zinc	10/100	601 001 2
2" (50)	Super Black	10/100	601 001 3

Fasteners included

# SHED & BARN HARDWARE

## LARGE DROP LATCH

SIZE INS (MM)	FINISH	QTY	CODE
10 1/2" (262)	Zinc	30	804 262 2
10 1/2" (262)	Black	30	804 262 3

Includes fasteners



## D-HANDLE LATCH (WHITCOMB)

SIZE INS (MM)	PIN LENGTH	FINISH	QTY PER BOX	CODE
5" (125)	5 3/4"	Zinc	10/40	807 125 2
5" (125)	5 3/4"	Black	10/40	807 125 3



## HOOK AND EYE

SIZE INS (MM)	FINISH	QTY PER BOX	CODE
4" (100)	Zinc	100	805 100 2



## CABIN HOOKS WIRE PATTERN

SIZE INS (MM)	FINISH	QTY PER BOX	CODE
4" (100)	Galvanized	5	532 100 1
4" (100)	Black	5	532 100 3
6" (150)	Galvanized	5	532 150 1
6" (150)	Black	5	532 150 3
8" (200)	Galvanized	5	532 200 1
8" (200)	Black	5	532 200 3
12" (300)	Galvanized	5	532 300 1
12" (300)	Black	5	532 300 3



Fasteners included

## HASP & STAPLE SWIVEL HEAD

SIZE INS (MM)	FINISH	QTY PER BOX	CODE
4 1/2" (115)	Zinc	10/100	602 006 2

Fasteners included



## EXHAUST VENTS

SIZE INS	FINISH	QTY PER BOX	CODE
4 x 16"	Brown	50	808 100 B
4 x 16"	White	50	808 100 W
8 x 16"	Brown	50	808 200 B
8 x 16"	White	50	808 200 W
8 x 16"	Mill	50	808 200 M







# POST SUPPORT PRODUCTS

Fencemate products are designed to help put up wood fencing, decking, and carports. They provide quality without hassle and ensure you produce a job that will last longer.



# POST SUPPORT PRODUCTS



## SWIFT CLAMP DRIVE IN POST SUPPORT

POST SIZE INS (MM)	LENGHT INS (MM)	FINISH	QTY PER BOX	CODE
3 1/2 x 3 1/2 (89 x 89)	30 (750)	S/Galvanized	1/8	260 090 1
3 1/2 x 3 1/2 (89 x 89)	30 (750)	E-Brown	1/8	260 090 3

Fits standard 4 x 4 post size.

These supports are suitable for most ground conditions. Robust construction ensures they will drive into very hard ground with ease and the effective clamp system will hold the post securely in the socket. Suitable for fence posts, decking, pergolas, gazebos, carports, and much more.

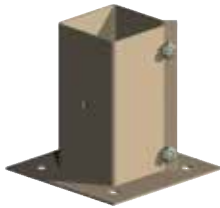

## SWIFT CLAMP BOLT DOWN POST SUPPORT

POST SIZE INS (MM)	FINISH	QTY PER BOX	CODE
3 1/2 x 3 1/2 (89 x 89)	S/Galvanized	1/10	262 090 1
3 1/2 x 3 1/2 (89 x 89)	E-Brown	1/10	262 090 3

Fits standard 4 x 4 post size.



## POST BRACKETS

POST SIZE INS (MM)	FINISH	QTY PER BOX	CODE
6 x 6 or 4 x 6	HDG	10	260 000 1
4 x 4	HDG	10	260 001 1

Thick guage, heavy duty.



# FIELDGATE HARDWARE

This section features an impressive range of robust hardware for farm and agriculture applications. Appropriate for five bar gates, 3" thick, heavy gates.



# FIELDGATE HARDWARE



## SPRING FASTENER SETS

SIZE INS (MM)	FINISH	QTY PER BOX	CODE
c/w Staple Catch	Galvanized	10	036 000 1
c/w Staple Catch Epoxy	Black	10	036 000 3

For installation behind post. Can operate from horseback.

## CENTRAL CLOSING GATE CATCHES

FINISH	QTY PER BOX	CODE
Galvanized	10	068 000 1

For use with the Spring Fastener Sets for latching in center of post.

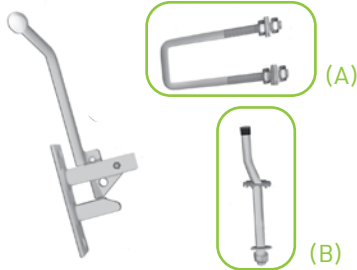

## HUNTING TYPE LOCKING GATE LATCHES

SIZE INS	FINISH	QTY PER BOX	CODE
17"	Galvanized	10	064 000 1

Very heavy duty

(A) Specify Double Leg Striker - 065 002 1

(B) Specify Cranked Leg Striker - 065 001 1

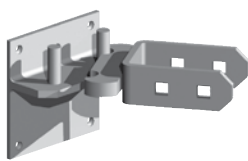

## RISING HINGES DOUBLE STRAP BANDS & ROCKER PLATES FOR 3" GATES

SIZE INS (MM)	FINISH	QTY PER BOX	CODE
5" (125)	Galvanized	1	056 125 1

Self closing. Includes all fasteners

For 3" thick gates

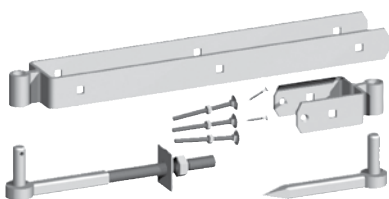

## STANDARD DOUBLE STRAP HINGE SETS

SIZE INS (MM)	FINISH	QTY PER BOX	CODE
12" (300)	Galvanized	4	030 300 1
12" (300)	Black	4	030 300 3
18" (450)	Galvanized	4	030 450 1
18" (450)	Black	4	030 450 3
24" (600)	Galvanized	4	030 600 1
24" (600)	Black	4	030 600 3

Includes all fasteners. For 3" thick gates.

# FIELDGATE HARDWARE

## ADJUSTABLE HINGE SETS

SIZE INS (MM)	FINISH	QTY PER BOX	CODE
12" (300)	Galvanized	4	032 300 1
12" (300)	Black	4	032 300 3
18" (450)	Galvanized	4	032 450 1
18" (450)	Black	4	032 450 3
24" (600)	Galvanized	4	032 600 1
24" (600)	Black	4	032 600 3

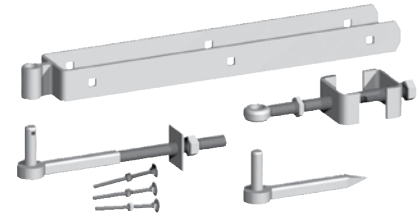

Includes all fasteners. For 3" thick gates.

## SAFETY GATE HOOK & EYES

DESCRIPTION	FINISH	QTY PER BOX	CODE
6" (150) C/W Chain & Eyes	Galvanized	5	528 150 1

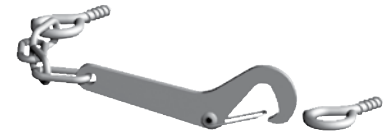

## THROWOVER LOOPS WITH LIFTING HANDLE FOR 3" GATES

SIZE INS (MM)	FINISH	QTY PER BOX	CODE
18" (450)	Galvanized	10	061 450 1
18" (450)	Epoxy Black	10	061 450 3

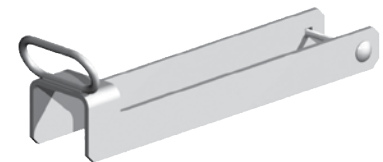

Comes with staple for locking.

## SPRING LOADED ANIMAL BOLTS

SIZE INS (MM)	FINISH	QTY PER BOX	CODE
1/2" (12) dia	E-Galvanized	5	516 012 2

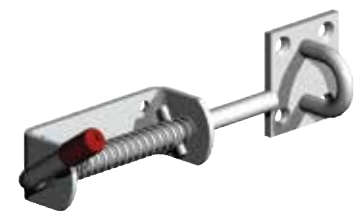

## LOCK THROUGH HOOKS - 3/4" PIN

SIZE INS (MM)	FINISH	QTY PER BOX	CODE
15" (375)	Galvanized	10	084 350 1

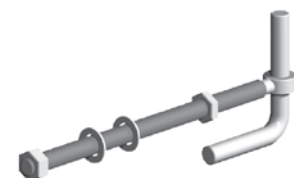

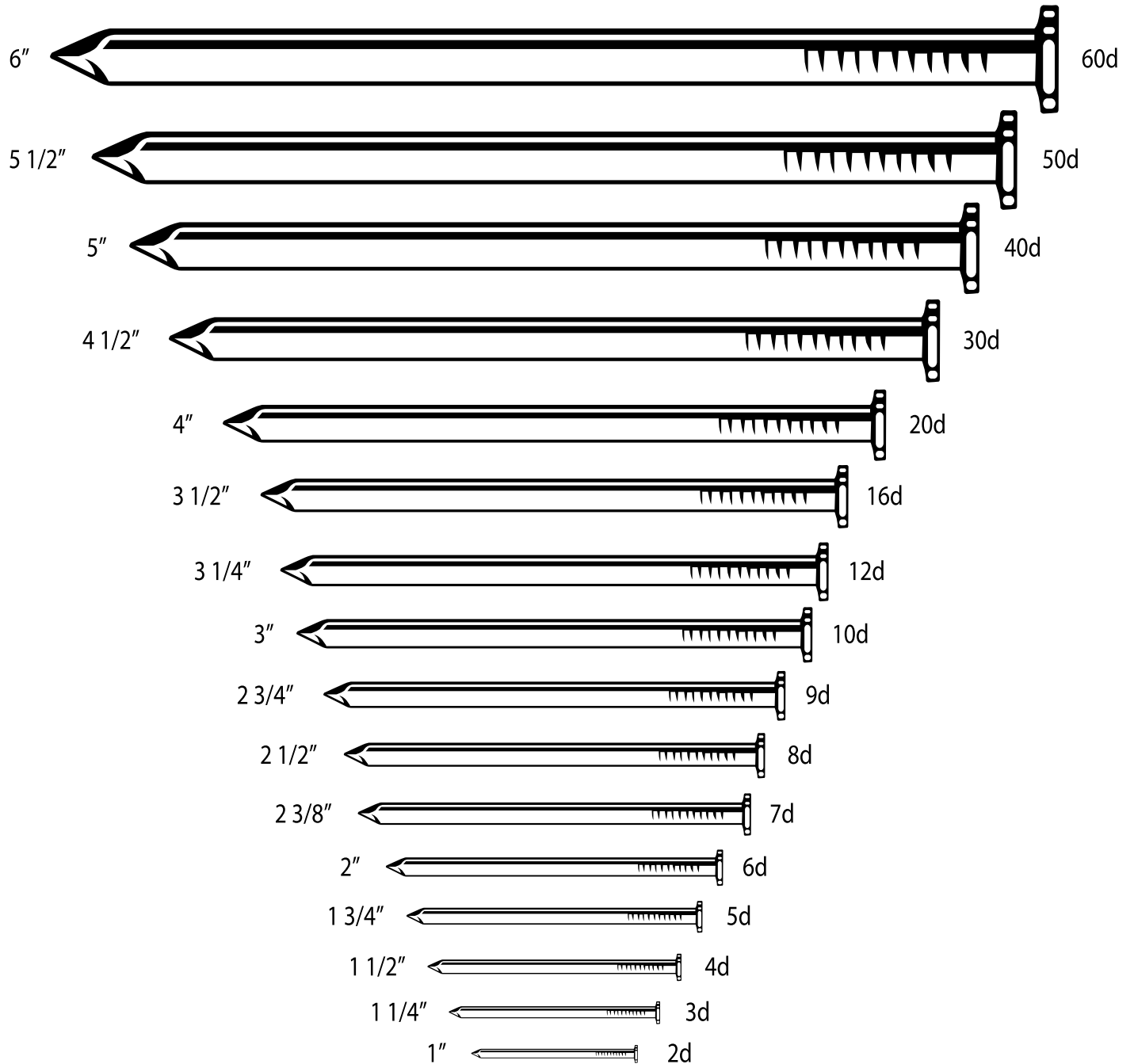



# NAILS & STAPLES

Conveniently order your nails along with gate hardware.  
Featuring quality nails at excellent value.





## HOT DIP GALVANIZED 21° STRIP NAIL

DESCRIPTION	FINISH	QTY PER BOX	CODE
2" x .113 Ring "6D"	HDG	5M	GM04HG
2" x .113 Smooth "6D"	HDG	5M	GM05HG
2 3/8" x .113 Ring "8D"	HDG	5M	GM08RHG
2 3/8" x .113 Smooth "8D"	HDG	5M	GM09HDG
2 3/8" x .148 Smooth	HDG	4M	GM8D148HG
3" x .120 Ring "10D"	HDG	4M	GM408HG
3" x .131 Smooth "10D Framer"	HDG	4M	GM033HG
3 1/4" x .120 Screw	HDG	4M	GM444SHG
3 1/4" x .131 Smooth "16D Short"	HDG	4M	GM034HG
3 1/4" x .131 Ring "16D Short"	HDG	4M	GMPS1031RHG

## ELECTRO GALVANIZED 21° GUN NAILS STRIP

DESCRIPTION	FINISH	QTY PER BOX	CODE
2" x .113 Ring "6D"	EG	4M	GM04G
2 3/8" x .113 Smooth	EG	5M	GM09G
3 1/4" x .131 Smooth "16D Short"	EG	4M	GM034G
3 1/4" x .131 Ring	EG	4M	GM83883



## 30° PAPER TAPE NAILS, EXTERIOR GALVANIZED

DESCRIPTION	FINISH	QTY PER BOX	CODE
2" x .113 Ring Shank 30°	HDG	2.5M	GMSP6DRHG
2 3/8" x .113 Ring Shank 30°	HDG	2.5M	GMSP8DRHG
3" x .120 Ring Shank 30°	HDG	2M	GMSP10DRHG
3 1/4" x .120 Ring Shank 30°	HDG	2M	GMSP12DRHG
1 1/2" x .148 Joist Hanger 33°	HDG	3M	GMSHFDCHG



## BULK HAND DRIVE BOX NAILS

SIZE	FINISH	BOX WEIGHT	CODE	DOMESTIC
2"	HDG	50 lbs	6HGBX	6DHDBOX
2 3/8"	HDG	50 lbs	7HGBX	7DHDBOX
2 1/2"	HDG	50 lbs	8HGBX	8DHDBOX
3 1/4"	HDG	50 lbs	12HGBX	12DHDBOX
3 1/2"	HDG	50 lbs	16HGBX	16DHDBOX
4"	HDG	50 lbs	20HGBX	
4 1/2"	HDG	50 lbs	30HGBX	
5"	HDG	50 lbs	40HGBX	40DHDBOX



## COIL NAILS - 0° PLASTIC COIL NAILS

DESCRIPTION	FINISH	QTY PER BOX	CODE
1 7/8" x .092 Ring	EG	9M	GM151G
1 7/8" x .092 Ring	HDG	9M	GM151HG
1 7/8" x .099 Screw	Aluminium	9M	GM149A
1 7/8" x .092 Ring	Stainless Steel	9M	GM150SS

## COIL NAILS - 15° WIRE COLLATED GALVANIZED

DESCRIPTION	FINISH	QTY PER BOX	CODE
1 1/4" x .080 Ring	HDG	3M	GMC3R80DHG
1 1/2" x .080 Ring	HDG	3M	GMC4R80DHG
1 3/4" x .080 Ring	HDG	3M	GMC5R80DHG
1 3/4" x .092 Ring	HDG	3M	GMC5R90DHG
2" x .092 Ring	HDG	3M	GMC6R90DHG
2 3/16" x .092 Ring	HDG	3M	GMC7R90DHG
2 1/2" x .092 Ring	HDG	3M	GMC8R90DHG
3" x .120 Ring	HDG	2.5M	GMC10RDHG
3 1/4" x .120 Ring	HDG	2.5M	GMC12RDHG



## COIL NAILS - 15° STAINLESS STEEL

DESCRIPTION	FINISH	QTY PER BOX	CODE
1 3/4" x .093 Ring	S/S	3.6M	GMC5R90DSS
2" x .093 Ring	S/S	3.6M	GMC6R90DSS
2 3/16" x .093 Ring	S/S	3.6M	802325
2 1/2" x .093 Ring	S/S	3.6M	80235S
3" x .120 Ring	S/S	2.5M	GMC10RDSS



We Recommend Stainless Steel on Cedar & Redwood

## COIL NAILS - 15° FLAT WOUND ELECTRO GALVANIZED

DESCRIPTION	FINISH	QTY PER BOX	CODE
1 3/4" x .090 Rin	EG	9,000	GM80313
2" x .090 Ring	EG	9,000	GM80321
2" x .099 Ring	EG	9,000	GM80081
2 1/2" x .090 Ring	EG	9,000	GM80345



## 18 GAUGE GALVANIZED BRADS

DESCRIPTION	FINISH	QTY PER BOX	CODE
1 1/4"	Galvanized	60M	85412
1 1/2"	Galvanized	60M	85418
1 3/4"	Galvanized	30M	85424
1 3/4"	Stainless	30M	854245
2"	Galvanized	30M	85427



ALSO AVAILABLE IN STAINLESS STEEL

## 15 GAUGE ANGLE FINISH NAILS - PA TYPE

DESCRIPTION	FINISH	QTY PER BOX	CODE
1 1/4"	Galvanized	16M	84668
1 1/2"	Galvanized	16M	84674
1 3/4"	Galvanized	16M	84680
2"	Galvanized	16M	84686
2 1/2"	Galvanized	8M	84695

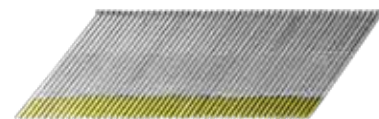

ALSO AVAILABLE IN STAINLESS STEEL

Also available in stainless steel

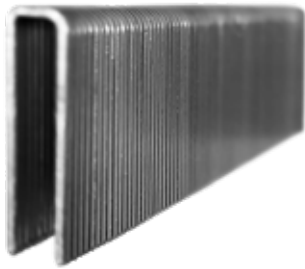

## STAPLES (1/4" NARROW CROWN - 16 GAUGE - GALVANIZED)

DESCRIPTION	QTY PER CASE	FINISH	CODE
1/2"	60M	GALVANIZED	GM87320
1/2"	60M	SS304	GM87320S
5/8"	60M	GALVANIZED	GM87325
5/8"	60M	SS304	GM87325S
3/4"	60M	GALVANIZED	GM87330
3/4"	60M	SS304	GM87330S
7/8"	60M	GALVANIZED	GM87335
7/8"	60M	SS304	GM87335S
1"	60M	GALVANIZED	GM87340
1"	60M	SS304	GM87340S
1 1/4"	30M	GALVANIZED	GM87350
1 1/4"	30M	SS304	GM87350S
1 1/2"	30M	GALVANIZED	GM87360
1 1/2"	30M	SS304	GM87360S

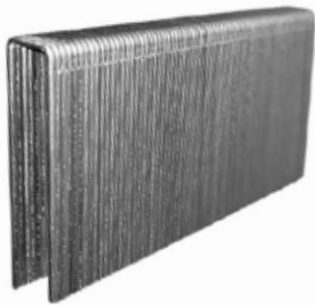

## STAPLES (7/16" MEDIUM CROWN - 16 GAUGE - GALVANIZED)

DESCRIPTION	QTY PER CASE	FINISH	CODE
1"	10M	GALVANIZED	GM86814
1"	10M	SS304	GM86814S
1 1/4"	10M	GALVANIZED	GM86819
1 1/4"	10M	SS304	GM86819S
1 1/2"	10M	GALVANIZED	GM86824
1 1/2"	10M	SS304	GM86824S
1 3/4"	10M	GALVANIZED	GM86829
1 3/4"	10M	SS304	GM86829S
2"	10M	GALVANIZED	GM86834
2"	10M	SS305	GM86834S



## COLLATED FENCE STAPLES - 10.5 GAUGE

DESCRIPTION	QTY PER CASE	FINISH	CODE
1 9/16"	1500	HDG	EF458HD-DCX
1 1/4"	2000	HDG	CFS114HDG

## FENCE STAPLES - 9 GAUGE BULK PACKED

DESCRIPTION	QTY PER CASE	FINISH	CODE
1"	50LB	HDG	1HGFS
1 1/4"	50LB	HDG	114HGFS
1 1/2"	50LB	HDG	112HGFS
1 3/4"	50LB	HDG	134HGFS
2"	50LB	HDG	2HGFS



## BARBED FENCE STAPLES - BULK PACKED

DESCRIPTION	QTY PER CASE	FINISH	CODE
1 3/4" X 9 GAUGE	50LB	HDG	118333
2" X 8 GAUGE	50LB	HDG	6BSC05



## VINEYARD STAPLES - 12 GAUGE BULK PACKED

DESCRIPTION	QTY PER CASE	FINISH	CODE
1 1/4"	50LB	HDG	114HG12FS
1 1/2"	50LB	HDG	112HG12FS



## CUSTOM SCREW PROGRAM

Save on all your screws & Bolts. Need something specific? We've got a wide selection and can source the exact length and finish you want.

*Speak to one of our pros today.*

# 1-866-98-ABB EY

### Customize Your Screws:

- Custom Color Heads to match your needs (most common requests are Black Powder Coating, Ipe, and White).
- Zinc and Stainless Steel Available.
- Self drilling & Self tapping.
- **Head options:**
  - HWH Unslot
  - HWH Slot
  - K-Lath Head Phillips
  - Pan Head Phillips
  - Phillips Modified Truss Head
  - Many More available
- Lengths from 3/4" - 8"
- Carriage Bolts up to 12"





# SCREWS & FASTENERS

A complete range of fasteners for decking, fencing, and associated trades. Square drive, Star drive, and Phillips available. Zinc, black, galvanized, bronze and stainless finishes.



# SCREWS & FASTENERS



RETAIL PACK



COUNTERSUNK PHILLIPS / SQUARE DRIVE WOOD SCREWS					
SIZE INS (MM)	FINISH	QTY PER BOX	CODE	RETAIL QTY/PK	RETAIL CODE
#6 x 1" (3.5 x 25)	Super Black	1200/12K	435 008 3	14	R35 008 3
#8 x 1" (4.2 x 25)	Super Black	1000/10K	435 021 3	14	R35 021 3
#10 x 1 1/2" (4.8 x 30)	Galvanized	500/5K	435 032 1	18	R35 032 6
#10 x 1 1/2" (4.8 x 30)	Zinc	500/5K	435 032 2		
#10 x 1 1/2" (4.8 x 30)	Super Black	500/5K	435 032 3	18	R35 032 3
#10 x 1 3/4"	Super Black	1700	435 033 3		
#10 x 2" (4.8 x 50)	Galvanized	400/4K	435 034 1	18	R35 034 6
#10 x 2" (4.8 x 50)	Zinc	400/4K	435 034 2		
#10 x 2" (4.8 x 50)	Super Black	400/4K	435 034 3	18	R35 034 3
#12 x 2" (5.5 x 50)	Zinc	300/3K	435 044 2		
#12 x 2" (5.5 x 50)	Super Black	300/3K	435 044 3	18	R35 044 3
#14 x 2 1/2" (6 x 60)	Super Black	200/2K	435 050 3	18	R35 050 3



316 stainless steel/Less obtrusive with great holding power/Same features as 7789 series but with a .26" Head Diameter/Great for Composite Decking, Rail & Fence. Also available in 1 lb. and 5 lb. jars.

316 STAINLESS STEEL TRIM HEAD STAR DRIVE				
SIZE	FINISH	DRIVE SIZE	CARTON QTY	CODE
#9 x 1 5/8"	Stainless	T20	4000	STH9158
#9 x 2 1/4"	Stainless	T20	2500	STH9214
#9 x 2 1/2"	Stainless	T20	2500	STH9212
#9 x 3"	Stainless	T20	2000	STH93
#9 x 4"	Stainless	T20	1500	STH94



Type 316 Stainless Steel/Deep Six Lobe Drive/Extra Sharp Type 17 Auger Point/Deep Wide Sharp Thread. Also available in 1 lb. and 5 lb. jars.

316 STAINLESS STEEL STAR DRIVE SCREWS				
SIZE	FINISH	DRIVE SIZE	CARTON QTY	CODE
#8 x 1 1/4"	Stainless	T20	9000	STX8114
#8 x 1 1/2"	Stainless	T20	6500	STX8112
#8 x 2"	Stainless	T20	3500	STX82
#9 x 1 5/8"	Stainless	T25	4000	STX9158
#9 x 2"	Stainless	T25	3000	STX92
#9 x 2 1/2"	Stainless	T25	2500	STX9212
#9 x 3	Stainless	T25	2000	STX93
#10 x 2 1/2"	Stainless	T25	2000	STX10212
#10 x 3"	Stainless	T25	1500	STX103
#10 x 3 1/2"	Stainless	T25	1000	STX10312
#10 x 4"	Stainless	T25	1000	STX104

# SCREWS & FASTENERS

## EXTERIOR USE STAR DRIVE WOOD SCREWS

SIZE	FINISH	DRIVE SIZE	CARTON QTY	CODE
#8 x 3/4"	Bronze	T20	10000	BTX834
#8 x 1"	Bronze	T20	10000	BTX81
#8 x 1 1/4"	Bronze	T20	9000	BTX8114
#8 x 1 1/2"	Bronze	T20	6500	BTX8112
#8 x 1 3/4"	Bronze	T20	4000	BTX8134
#8 x 2"	Bronze	T20	3500	BTX82
#9 x 1 1/2"	Bronze	T25	3500	BTX9112
#9 x 2"	Bronze	T25	3000	BTX92
#9 x 2 1/2"	Bronze	T25	2500	BTX9212
#9 x 2 3/4"	Bronze	T25	2000	BTX9234
#9 x 3"	Bronze	T25	2000	BTX93

## #10 x HEAVY DUTY

#10 x 2"	Bronze	T25	2500	BTX102
#10 x 2 1/2"	Bronze	T25	2000	BTX10212
#10 x 3"	Bronze	T25	1500	BTX103
#10 x 3 1/2"	Bronze	T25	1000	BTX10312
#10 x 4"	Bronze	T25	1000	BTX104
#10 x 5"	Bronze	T25	750	BTX105
#10 x 6"	Bronze	T25	600	BTX106



ACQ Compatible Coating/Flat Head with 16 Nibs for easy self countersinking/Extra Sharp type 17 Auger Point/Large Knurled Shank/Deep, Wide, Sharp Threads/Heat Treated, Hardened Steel. Also available in 1 lb. and 5 lb. jars.

## #7 X EXTERIOR USE FINISH SCREWS

SIZE	FINISH	DRIVE SIZE	CARTON QTY	CODE
#7 x 1 5/8"	Bronze	T10	5500	FS7158
#7 x 2"	Bronze	T10	4000	FS72
#7 x 2 1/2"	Bronze	T10	3000	FS7212
#7 x 3"	Bronze	T10	2500	FS73



Smallest "Star Drive" Trim Head Available/Type 17 Auger Point/Deep, Wide, Sharp Threads/Knurled Shank/Head Treated, Hardened Steel. Also available in 1 lb. & 5 lb. jars.

## EXTERIOR USE TRIM HEAD STAR DRIVE WOOD SCREWS

SIZE	FINISH	DRIVE SIZE	CARTON QTY	CODE
#9 x 1 5/8"	Bronze	T20	4000	THB9158
#9 x 2"	Bronze	T20	3000	THB92
#9 x 2 1/2"	Bronze	T20	2500	THB9212
#9 x 3"	Bronze	T20	2000	THB93
#9 x 4"	Bronze	T20	1500	THB94
#9 x 5"	Bronze	T20	1000	THB95



ACQ Compatible Coating/Deep, Wide, Sharp Threads/Knurled Shank/Type 17 Auger Point/Hardened Steel. Also available in 1 lb. and 5 lb. jars

# SCREWS & FASTENERS



ACQ Compatible Coating/Extra Sharp Type 17 Auger Point/Washer Head/Deep, Wide, Sharp Threads/Hardened Steel. Also available in 1 lb. and 5 lb. jars

## EXTERIOR USE 'STAR DRIVE' CABINET SCREWS (Modified Truss Head .412 Head Dia)

SIZE	FINISH	DRIVE SIZE	CARTON QTY	CODE
#8 x 1 1/4"	Bronze	T15	4000	CAB8114
#8 x 1 5/8"	Bronze	T15	3000	CAB8158
#7 x 2"	Bronze	T15	2000	CAB72
#7 x 2 1/2"	Bronze	T15	1500	CAB7212



Round Washer Head/Extra Sharp Type 17 Auger Point/Deep Sharp Spiral/Hardened Steel. Also available in 50ct and 100ct jars.

## EXTERIOR USE CONSTRUCTION LAG SCREWS 1/4" Nominal, 1/2" Head Dia

SIZE	FINISH	DRIVE SIZE	CARTON QTY	CODE
1/4" x 1"	Bronze	T25	2000	CTX141
1/4" x 1 1/2"	Bronze	T25	1500	CTX14112
1/4" x 2"	Bronze	T25	1000	CTX142
1/4" x 2 1/2"	Bronze	T25	750	CTX14212
1/4" x 3"	Bronze	T25	600	CTX143
1/4" x 4"	Bronze	T25	500	CTX144
1/4" x 5"	Bronze	T25	500	CTX145
1/4" x 6"	Bronze	T25	400	CTX146



Round Washer Head/Extra Sharp Type 17 Auger Point/Deep Sharp Spiral/Hardened Steel. Also available in 50ct and 100ct jars.

## EXTERIOR USE CONSTRUCTION LAG SCREWS 5/16" Nominal, 5/8" Head Dia

SIZE	FINISH	DRIVE SIZE	CARTON QTY	CODE
5/16" x 2"	Bronze	T30	700	CTX152
5/16" x 2 1/2"	Bronze	T30	600	CTX15212
5/16" x 3"	Bronze	T30	500	CTX153
5/16" x 3 1/2"	Bronze	T30	500	CTX15312
5/16" x 4"	Bronze	T30	400	CTX154
5/16" x 5"	Bronze	T30	350	CTX155
5/16" x 6"	Bronze	T30	300	CTX156



Round Washer Head/Extra Sharp Type 17 Auger Point/Deep Sharp Spiral/Hardened Steel. Also available in 50ct and 100ct jars.

## EXTERIOR USE CONSTRUCTION LAG SCREWS 3/8" Nominal, 1 1/16" Head Dia

SIZE	FINISH	DRIVE SIZE	CARTON QTY	CODE
3/8" x 4"	Bronze	T40	250	CTX174
3/8" x 5"	Bronze	T40	250	CTX175
3/8" x 6"	Bronze	T40	250	CTX176
3/8" x 7"	Bronze	T40	250	CTX177
3/8" x 8"	Bronze	T40	250	CTX178
3/8" x 10"	Bronze	T40	250	CTX1710
3/8" x 12"	Bronze	T40	250	CTX1712
3/8" x 14"	Bronze	T40	250	CTX1714
3/8" x 16"	Bronze	T40	250	CTX1716

# SCREWS & FASTENERS

BRONZE COATED STAR DRIVE CABINET SCREWS 1/2" Head Diameter				
SIZE	FINISH	DRIVE SIZE	CARTON QTY	CODE
#10 x 2 1/2"	Bronze	T25	2000	CAB10212
#10 x 3"	Bronze	T25	1500	CAB103



Yellow Zinc Coated, Type 17 Auger point, Deep, Sharp, Wide Threads, Hardened Steel. Also available in 1 lb. and 5 lb. jars

STAR DRIVE CEMENT BOARD SCREWS				
SIZE	FINISH	DRIVE SIZE	CARTON QTY	CODE
#8 x 1 1/4"	Ceramic	T20	5000	CB114S
#8 x 1 1/4"	Ceramic w/Drill Point	T20	5000	CB114D
#8 x 1 5/8"	Ceramic	T20	4000	CB158S
#8 x 1 5/8"	Ceramic w/Drill Point	T20	4000	CB158D



Ceramic Coated - For interior and exterior use. Sharp point for cement board to wood and drill point for cement board to metal. Also available in 1 & 5 LB jars.

## STAR DRIVE BITS & BIT HOLDERS

"STAR DRIVE" BITS		
DRIVE/CODE	SIZE	CARTON/BOX QTY
T10	1" & 2"	25/200
T15	1" & 2"	25/200
T20	1" to 6"	25/200
T25	1" to 6"	25/200
T30	1" & 2"	25/200
T40	1" & 2"	25/200



BIT HOLDERS				
DESCRIPTION	SIZE	10 QTY CODE	25 QTY CODE	
Magnetic Bit Holder with Slip collar	1/4" x 2 1/4"		MBHC2	
Magnetic Bit Holder	2 3/8"		MBH2	
Magnetic Bit Holder	3"		MBHD	
Quick Release Magnetic Bit Holder	2 3/8"		QMBH	
Quick Release Magnetic Bit Holder	4"	QMBH4J	QMBH4	
Quick Release Magnetic Bit Holder	6"	QMBH6J	QMBH6	



# SCREWS & FASTENERS



HEX WASHER HEAD INDENT SELF DRILLING #3 POINT			
SIZE IN (MM)	FINISH	QTY PER BOX	CODE
#10-16x3/4"	ZINC	8000	636242
#10-16x1"	ZINC	3300	693140
1/4"-14x3/4"	ZINC	2300	693221
1/4"-14x1"	ZINC	1700	693230
1/4"-14x1"	SSBLACK	2000	693230SSBLACK
1/4"-14x1" - with washer	ZINC/BLACK	2000	693230BLACK
1/4"-14x1"	SSWHITE	2000	693230SSWHITE
1/4"-14x1" - with washer	ZINC/WHITE	2000	693230WHITE
1/4"-14x1 1/2"	ZINC	1300	693240
1/4"-14x2"	BLACK	1000	693250BLACK
1/4"-14x2"	ZINC	1500	636288
1/4"-14x2"	SS	500	040250
1/4"-14X2 1/2"	ZINC	1000	693260
1/4"-14x3"	ZINC	1000	636290/693265
1/4"-14x3"	SS	1000	040265

Other Size and Finishes available.



Reamer Wings/Shank Slot/Hardened Steel/  
Zinc Plated/For up to 1/4" thick steel with no  
predrilling. ACQ compatible. Also available  
in 1 lb. and 5 lb. jars.

WOOD TO STEEL STAR DRIVE SCREWS							
SIZE	HEAD DIA	DRIVE SIZE	DRILL POINT	DRILL CAPACITY	QTY PER BOX	CODE	
#10-16 x 1 5/8"	.361"	T25	#3	7/8" wood to .175 metal	4000	FHD10158	
#12-24 x 2"	.396"	T25	#4	1 1/8" wood to .210 metal	2000	FHD122	
#12-24 x 2 1/2"	.396"	T25	#4	1 1/4" wood to .210 metal	1500	FHD12212	
#14-20 x 2 3/4"	.49"	T30	#4	1 1/2" wood to .250 metal	1000	FHD14234	
#14-20 x 3 1/4"	.49"	T30	#4	2" wood to .250 metal	1000	FHD14314	



K - LATH PHIL MODIFIED TRUSS SHARP POINT SCREWS			
SIZE IN (MM)	FINISH	QTY PER BOX	CODE
#8 X 3/4"	ZINC	8000	W75034



K-LATH PHIL MODIFIED TRUSS SELF DRILLING SCREWS			
SIZE IN (MM)	FINISH	QTY PER BOX	CODE
#8-18 x 3/4"	ZINC	8000	693622
#8-18 X 1"	ZINC	100	693624
#8-18X 1 1/4"	ZINC	6000	636016
#8-18x2"	ZINC	4000	693634
#10-16x3/4"	ZINC	6500	636102

# SCREWS & FASTENERS

HEX SCREWS					
SIZE INS (MM)	FINISH	QTY PER BOX	CODE	RETAIL QTY/PK	RETAIL CODE
1/4" X 1 1/4"	ZINC	2250	486112		
1/4" X 2" (6 X 50)	HDG	2000	H060501	18	R060501
1/4" X 2" (6 X 50)	ZINC	1425	486126		
1/4" X 2" (6 X 50)	BLACK	1425	H060503	18	R060503
5/16" X 2 (8 X 50)	HDG	1000	H080501	18	R080501
5/16" X 2 (8 X 50)	ZINC	750	486226		
5/16" X 2 (8 X 50)	BLACK	750	H080503	18	R080503
3/8" X 2 1/2	ZINC	50	486336		
5/16" X 3"	HDG	625	487244		
3/8" X 3"	ZINC	350	486344		
1/4" X 3 1/2"	ZINC	875	486156		
3/8" X 3 1/2"	ZINC	375	486356		
3/8" X 5"	HDG	250	487370		
3/8" X 5"	ZINC	300	494061		
5/8" X 5"	HDG	375	487270		



1/4" Hex up to 4" length zinc.  
5/16" Hex up to 6" length zinc.  
3/8" Hex up to 8" length zinc.  
7/16" Hex up to 8" length zinc.

Other Size and Finishes available.

TIMBER HEX 5/16" HEX HEAD				
SIZE	FINISH	DRIVE SIZE	QTY PER BOX	CODE
#14 X 2"	Black Ceramic	5/16" Hex	500	BL142
#14 X 2 1/2"	Black Ceramic	5/16" Hex	350	BL14212
#14 X 4"	Black Ceramic	5/16" Hex	250	BL144
#14 X 6"	Black Ceramic	5/16" Hex	250	BL146
#14 X 8"	Black Ceramic	5/16" Hex	250	BL148
#14 X 10"	Black Ceramic	5/16" Hex	250	BL1410
#14 X 12"	Black Ceramic	5/16" Hex	250	BL1412
#14 X 14"	Black Ceramic	5/16" Hex	250	BL1414
#17 X 4"	Gray Ceramic	5/16" Hex	250	BL174
#17 X 5"	Gray Ceramic	5/16" Hex	250	BL175
#17 X 6"	Black Ceramic	5/16" Hex	250	BL176



Landscaping timber fastener.  
The superior alternative to spikes.  
Available in 50 ct.

## SCRAIL® – THE SCREW THAT YOU CAN SHOOT THROUGH A NAIL GUN

**Shoots like a nail, backs out like a screw / 90% Stronger than Ring Shank Nails**

**Saves time and labor costs / Available to fit most Nail Guns / Also available in EG and Stainless Steel**



### 21° PLASTIC STRIP SCRAIL®

SIZE	THREAD TYPE/FINISH	DRIVE/DIA	QTY PER BOX	CODE
2"	COARSE/FasCoat®	Philips/.113	1000	SCFP613CPFC
2"	BeckDeck®/FasCoat®	Square/.120	1000	SCFP620CTSFC
2 1/4"	BeckDeck®/FasCoat®	Square/.120	1000	SCFP720CTSFC
2 1/2"	FINE/FasCoat®	Square/.113	1000	SCFP21213FSFC
2 1/2"	COARSE/FasCoat®	Philips/.113	1000	SCFP21213CPFC
2 1/2"	COARSE/FasCoat®	Versa/.113	1000	SCFP21213CVFC
2 1/2"	BeckDeck®/FasCoat®	Square/.120	1000	SCFP21220CTSFC
3"	COARSE/FasCoat®	Square/.113	1000	SCFP1013CSFC
3"	COARSE/FasCoat®	Versa/.113	1000	SCFP1013CVFC

Suitable for DUOFAST CN350B, NSP350FI, HITACHI NR83A2, NR90AC3, SENCO FP602, FP652, FP752XP, FP702XP, FASCO F6AC RHN20-100A SCR SS/CT, RHN20-100



### 15° WIRE COIL SCRAIL®

SIZE	THREAD TYPE/FINISH	DRIVE/DIA	QTY PER BOX	CODE
2"	FINE/FasCoat®	Square/.113	2000	SCWC613FSFC
2 1/4"	BeckDeck®/FasCoat®	Square/.120	2000	SCWC720CTSFC
2 1/2"	FINE/FasCoat®	Versa/.113	2000	SCWC21213FVFC
2 1/2"	COARSE/FasCoat®	Square/.113	2000	SCWC21213FSFC
3"	BeckDeck®/FasCoat®	Square/.120	2000	SCWC1020CTSFC
3"	COARSE/FasCoat®	Versa/.113	2000	SCWC1013FVFC

Suitable for BOSTITCH N75C-1, N89C-1, N100C, N80CB, HITACHI NV65AB, NV65AC, NV832A2, MAXCN70, CN80, PASLODE P275C, P350C, F325C, SENCO PALLET PRO 70, SCN60, SCN65, FASCO F6AC CN15W-90B SCR SS/CT



### 15 DEGREE PLASTIC SHEET COIL SCRAIL®

SIZE	THREAD TYPE/FINISH	DRIVE/DIA	QTY PER BOX	CODE
1 3/4"	FINE/FasCoat®	Torx/.113	2000	SCMP513FTFC
2 1/4"	COARSE/FasCoat®	Philips/.113	2000	SCMP713CPFC

Suitable for BOSTITCH N75C-1, N89C-1, N100C, N80CB, HITACHI NV65AB, NV83A2, MAX CN70, CN80, PASLODE 275C, P350C, F325C, SENCO PALLET PRO 70, SCN60, SCN65, P350, CN80, PASLODE P275C, P350C, F325C, HITACHI NV65AH, NV75AG, MAXCN565, CN890S, FASCO F45C CNW15W-PS65L SA SCR SS/CT

# SCREWS & FASTENERS

CARRIAGE BOLTS			
SIZE INS (MM)	FINISH	QTY PER BOX	CODE
5/16"-18X4"	HDG	375	490090
3/8" X 3 7/8"	BLACK	200	C100903
7/16" X 4 1/4"	HDG	200	C121101
5/8"-11X12"	HDG	25	490045



Other Size and Finishes available.

CONCRETE SCREW				
SIZE INS / DESCRIPTION	QTY PER BOX	FINISH	CODE	
1/4"x2 1/4" FLAT HEAD PHIL COMMERCIAL BLUE FINISH	1500	BLUE	685044	
1/4"x4" INDENT HWH SLOT COMMERCIAL CONCRETE SCREWS BLUE FINISH	800	BLUE	685254	



CONCRETE SCREW HD ANCHOR				
SIZE INS	FINISH	QTY PER BOX	CODE	
1/2" X 4"	ZINC	30	044123	
1/2" X 5"	ZINC	25	044124	
5/8" X 4"	ZINC	30	044162	



Other Size available.



See page 80 for HWH Screws.

# SCREWS & FASTENERS

ALSO  
AVAILABLE IN  
STAINLESS  
STEEL



Ratings available upon request.

## ULTRAWEDGE ANCHOR - STEEL

SIZE - PITCH	LEN.	FINISH	QTY/CASE	CODE
3/8"-16	2 1/4"	Zinc	600	279040
3/8"-16	2 3/4"	Zinc	600	279050
3/8"-16	3"	Zinc	600	279060
3/8"-16	3 1/2"	HDG	400	158010
3/8"-16	3 3/4"	Zinc	400	279080
3/8"-16	5"	Zinc	500	279090
3/8"-16	6 1/2"	Zinc	300	279440
1/2"-13	2 3/4"	Zinc	300	279100
1/2"-13	2 3/4"	HDG	300	158100
1/2"-13	3 3/4"	Zinc	200	279110
1/2"-13	3 3/4"	HDG	200	158110
1/2"-13	4 1/4"	Zinc	200	279120
1/2"-13	4 1/4"	HDG	200	158120
1/2"-13	4 1/2"	Zinc	200	279130
1/2"-13	5 1/2"	Zinc	150	279140
1/2"-13	5 1/2"	HDG	150	158130
1/2"-13	7"	Zinc	100	279150
1/2"-13	7"	HDG	100	158140
1/2"-13	8 1/2"	Zinc	75	279160
1/2"-13	8 1/2"	HDG	75	158150
1/2"-13	10"	Zinc	75	279170
1/2"-13	10"	HDG	75	158160
1/2"-13	12"	Zinc	75	279180
5/8"-11	3 1/2"	Zinc	150	279190
5/8"-11	3 1/2"	HDG	150	158200
5/8"-11	4 1/2"	Zinc	150	279200
5/8"-11	5"	Zinc	100	279210
5/8"-11	5"	HDG	100	158210
5/8"-11	6"	Zinc	100	279220
5/8"-11	6"	HDG	100	158220
5/8"-11	7"	Zinc	75	279230
5/8"-11	7"	HDG	75	158230
5/8"-11	8 1/2"	Zinc	70	279240
5/8"-11	8 1/2"	HDG	70	158240
5/8"-11	10"	Zinc	30	279250
5/8"-11	10"	HDG	30	158250
5/8"-11	12"	Zinc	30	279260



# TOOLS

This section features a wide variety of quality and unique tools for the Fencing Trade including pneumatic tools, hand tools and augers.



## NAIL GUNS



### COIL SIDING NAILER

#### USE WITH

15° Wire Coil Nails, 15° Plastic Sheet Coil Nails

#### CODE

F44AC CN15PS

- Easy to handle thanks to light weight and good balance
- Drives both wire welded and plastic sheet collated coil nails
- Fully pneumatic feeding and positioning system allows precise nailing
- Includes switchable trigger for full sequential fire and bump fire
- Tool-free depth control
- Rubber comfort grip and adjustable exhaust
- Removable no mar tip

UNIQUE  
PRODUCT



### LOW CAP FRAMING NAILER

#### USE WITH

17° + 20° Plastic Strip Nails,

#### CODE

F58AC RHN20-90C

- 20° Plastic Strip SCRAIL® (fine and coarse threads) and 20° BeckDeck® double threaded SCRAIL®
- Compatible with 20° as well as 17° Plastic Strip Nails
  - Also compatible with 20° Plastic Strip SCRAIL® (fine and coarse threads) and 20° BeckDeck® double threaded SCRAIL®
  - Patent pending design with good ergonomics and excellent tool balance
  - New, easy jam clearing system: total release of the complete magazine
  - Plastic protection against wood chips and splinters
  - Includes a patented sequential fire / bump fire (Single Shot / Contact Trip) device
  - Reduced weight thanks to low tool profile

### ZERO DEGREE SIDING NAILER

#### USE WITH

0° Plastic Sheet Coil Nails (CN)

#### CODE

F44AC CN0-PS65



- Drives 0° plastic sheet coil nails
- Easy to handle thanks to light weight and good balance
- Fully pneumatic feeding and positioning system allows precise nailing
- Includes switchable trigger for full sequential fire and bump fire
- Tool-free depth of drive adjustment
- Rubber comfort grip and adjustable exhaust
- Belt hook
- Removable no mar tip

## SCRAILER/COIL SIDING NAILER

### USE WITH

15° Wire and Plastic Sheet Coil

### CODE

F50C

- Rubber comfort grip ensures a non-slip handling and reduces vibrations and fatigue
- High impact engineered plastic magazine with adjustable bottom steel plate
- Fully pneumatic feeding and positioning system to precise nailing even at low pressures
- Body and cap in high strength magnesium allow for a good balance and ease of handling
- Includes a patented sequential fire / bump fire (Single Shot / Contact Trip) device, which is the safest in the world



UNIQUE  
PRODUCT

## MEDIUM CROWN STAPLER

### USE WITH

7/16" Crown Staples

### CODE

F44AC G-50

- Patent pending design with good ergonomics
- Rubber comfort grip ensures a non-slip handling and reduces vibrations and fatigue
- Limited recoil resulting from balanced weight distribution
- Tool-less jam clearing mechanism provides an easy access to the nose if the staple jams
- Magazine guide opening bar for an easy staple loading
- Multi-directional exhaust adjusts without tools
- Depth control dial for precise countersinking
- Solid and durable design for the most demanding jobs



## HEAVY GAUGE FENCE STAPLER

### USE WITH

F40-315 Fence Staples

### CODE

F46 40-315

- Good balance and reduced weight
- High power for hardwood applications
- Rubber comfort grip ensures a non-slip handling and reduces vibration and fatigue
- Special nose for fence application
- Multi-directional exhaust adjusts without tools
- Tool-free depth of drive adjustment
- Special mechanism prevents double shots
- Solid and durable design for the most demanding jobs



UNIQUE  
PRODUCT

For use with Collated Fencing Staples. See page 72.





## GAS FIRED FENCING STAPLER

### USE WITH

EF40-315 Fence Staples

### CODE

F70G

- Powerful cordless tool to countersink 45mm (1 3/4") fence staples in pressure treated lumber
- Good balance and reduced weight
- Rubber comfort grip ensures a non-slip handling
- Belt hook
- Special nose for fence application
- Tool-free depth of drive adjustment
- Top loading magazine holds 75 staples
- Single shot actuation
- Works with Fasco fuel cells
- Powerful NiMh battery
- Lights indicate battery charge



## NARROW CROWN STAPLER

### USE WITH

BeA 90, Duo-Fast 18, Haubold 6000, Senco N4450 (L Staples)

### CODE

F21P 90-25A

- Designed with a long and narrow nose for an excellent job visibility
- Rubber comfort grip ensures a non-slip handling and reduces vibrations and fatigue
- One hand latch for a faster reloading and reduced downtime
- Reversible bumper for high durability and increased parts life
- Wide air storage for a high speed



## BRADDER

### USE WITH

GN Brads (18 gauge)

### CODE

F2B GN-50

- Rubber comfort grip ensures a non-slip handling and reduces vibrations and fatigue
- No-mar tip avoids marking of soft wood
- Two finger trigger delivers great control and reduces finger fatigue
- Side window to see visible brads for reducing the incidence of dry-fire
- Patented Quick Clear permits the magazine to slide away from nose to clear jams



## COMPRESSOR

### DESCRIPTION

2HP 4 GAL with wheels

### CODE

GM2540

Ultra quiet 1725 RPM motor, 10" no-flat tire never loses air, 4 gallon tank capacity, Only weighs 90 lbs., retractable handle, Max PSI is 150, Pump Up: 76 seconds, Recovery: 18 seconds

## GROUND HOG TOWABLE HYDRAULIC EARTHDRILL

ENGINE	CODE
9hp (6.75kw) Honda Engine 9X270	HD99

- Variable speed, Forward and Reverse auger rotation
- Three handlebar positions; two for normal drilling and one for close up drilling and towing
- Drilling head pivots from side to side for drilling on uneven terrain
- No torque to the operator
- Engine frame swivels to keep engine level for optimum performance
- Replaceable steel bushing at pivot points
- Auger locks up out of the way for easy maneuvering
- Durable powder coated finish
- Large 5.70x8 pneumatic highway rated tires for easy maneuvering and towing
- Towable. Includes tow bar with 2" hitch coupler
- 7/8" square auger drive fits all Ground Hog augers up to 18"
- 275 ft. lbs. of torque and 140 rpm approx. max. auger speed
- 6 gpm pump
- High pressure hydraulic swivels for free digging head movement and longer hose life



## GROUND HOG ONE-MAN MECHANICAL EARTHDRILL

ENGINE	CODE
Two Options: Honda GX160 and Briggs & Stratton Intek	1M5C

- Ground Hog's time tested transmission
- Durable powder coated finish
- Easy to maneuver on rough or soft terrain
- 7/8" square auger drive
- Tubular steel drive shaft
- No torque to operator
- Uses augers up to 12" in diameter
- Large pneumatic wheels and tires
- Low maintenance & Light Weight
- Easy to load into truck or trailer
- Easy to use operator controls
- Will handle the hardest soils



*We guarantee the performance and quality of every one of our products.*



## GROUND HOG TWO-MAN EARTHDRILL

ENGINE	CODE
Two Options: Honda and Briggs & Stratton Intek	C-71-5

- Ground Hog's time tested transmission
- Low maintenance
- Easily transported
- Rapid Return on Investment
- 7/8" square auger drive
- Heavy wall steel handlebars
- Aluminum Castings for strength and light weight
- Centrifugal clutch with needle bearings and all metal shoes and drum
- Trigger-type return-style throttle
- Heavy Duty cog-type drive belt
- Will handle the hardest soils
- Handles up to a 12" auger



## GROUND HOG HANDHELD EARTHDRILL

ENGINE	CODE
Honda® GX35 4-Stroke Engine	Model One

- Designed for Commercial and Rental use
- Rapid Return on Investment
- Heavy-duty transmission with oversized bearings
- Heat treated billet steel gears
- Cast aluminum gear case is reinforced with thick ribs to handle rough use and side loads
- Cushioned wrap-around grips
- Trigger-type spring-return throttle
- Comfortable hole starting height
- 1" Round Auger Drive
- Handles up to an 8" auger bit
- Bits are available in 2", 4", 6" and 8"
- New, unique blade type that results in drastically longer blade life
- Durable powder coated finish



## GROUND HOG PENGU STYLE AUGER

DESCRIPTION	CODE
2" Auger with Pengo Style blades	PSD2
4" Auger with Pengo Style blades	PSD4
6" Auger with Pengo Style blades	PSD6
7" Auger with Pengo Style blades	PSD7
8" Auger with Pengo Style blades	PSD8
9" Auger with Pengo Style blades	PSD9
10" Auger with Pengo Style blades	PSD10
12" Auger with Pengo Style blades	PSD12
14" Auger with Pengo Style blades	PSD14
16" Auger with Pengo Style blades	PSD16
18" Auger with Pengo Style blades	PSD18

14", 16", and 18" diameter augers are only for use with the HD99 Hydraulic Earthdrill.

## GROUND HOG COMBO AUGERS

DESCRIPTION	CODE
6" All-purpose blade configuration	CSD6
7" All-purpose blade configuration	CSD7
8" All-purpose blade configuration	CSD8
9" All-purpose blade configuration	CSD9
10" All-purpose blade configuration	CSD10
12" All-purpose blade configuration	CSD12



## GROUND HOG STANDARD AUGERS

DESCRIPTION	CODE
6" Loose soil blade configuration. Standard Style Digging head.	SD6
7" Loose soil blade configuration. Standard Style Digging head.	SD7
8" Loose soil blade configuration. Standard Style Digging head.	SD8
9" Loose soil blade configuration. Standard Style Digging head.	SD9
10" Loose soil blade configuration. Standard Style Digging head.	SD10
12" Loose soil blade configuration. Standard Style Digging head.	SD12



## GROUND HOG RD SERIES AUGERS FOR THE MODEL ONE

DESCRIPTION	CODE
2"	RD2
4"	RD4
6"	RD6
8"	RD8



## GROUND HOG CHIPPER

DESCRIPTION	CODE
Bolt-on Chipper for Standard Augers	101C

Optional bolt-on blade for use on Standard series augers 6-inch and larger. For digging in tougher soils.



## GROUND HOG FISHTAIL PILOT

DESCRIPTION	CODE
Fishtail Center Pilot Bit	100

Screw-in pilot bit used on Ground Hog Standard, Combo, and ModelOne (RD Series) augers. Has hardfaced tips.





## PENGO STYLE WISDOM TOOTH

DESCRIPTION	CODE
Pengo Style Side Blade (Comes standard on Combo and Pengo style augers)	PB35
Hardfaced Pengo 35 Style Side Blade	35HF
Carbide Version of the Pengo Style 35 Wisdom Tooth	1336

Comes with Rubber lock.

Optional tooth for Ground Hog Combo and Pengo style augers. It fits in place of a 35 blade and has a carbide cutting edge for longer life in hard soil. On augers with 2 side blades this tooth is usually used in the outside tooth pocket and used in conjunction with a 5T30c blade in the inside pocket for the highest performance blade setup we offer.



## PENGO STYLE SUPER TOOTH

DESCRIPTION	CODE
Super Tooth Pengo	5T30
Carbide Super Tooth Pengo	5T30-C

Works for combo and Pengo Augers.



## PENGO STYLE PILOT BITS

DESCRIPTION	CODE
Pilot Bit	SB-25
Carbide Tipped Pilot Bit	SB-25C
Full Carbide Pilot Bit	SB-25CXC



## GROUND HOG BLADES FOR STANDARD AUGERS

DESCRIPTION	CODE
For SD4 Auger	400
For SD6 and SD7 Augers	670
For SD8, SD9 and SD10 Augers	8910
For SD12 Auger	912



## GROUND HOG MODEL ONE SIDE TEETH

DESCRIPTION	CODE
1 for 4", 2 for 6", 3 for 8"	468

Reversible - both sides can be used.



## GROUND HOG AUGER EXTENSION

DESCRIPTION	CODE
1'	EX1
2'	EX2

## GROUND HOG AUGER ADAPTER

DESCRIPTION	CODE
Little Beaver® Auger Adapter (push button connection)	AA-LB
General® Auger Adapter (1 3/8" Hex Drive)	AA-GE



## GROUND HOG AUGER ATTACHMENT PIN

DESCRIPTION	CODE
Pin and Clip for Pengo, Combo and Standard Augers	1300
Pin and Clip for RD Series Augers (Model One)	RD300



All Augers come with 1 Pin.

## LITTLE BEAVER

### LITTLE BEAVER EARTH DRILL MECHANICAL POST HOLE DIGGER

DESCRIPTION	CODE
5.5 HP Honda Engine with Roll Cage and 10" Flat Free Tires / available with different gear ratios	MDL-5HPR7



### LITTLE BEAVER EARTH DRILL MECHANICAL POST HOLE DIGGER

DESCRIPTION	CODE
8HP Honda Engine - no Roll Cage / available with different gear ratios	MDL-8H



### LITTLE BEAVER STANDARD SERIES AUGER

DESCRIPTION	CODE
4" X 36" Standard Style Blades	4X36-SSS
4" X 42" Standard Style Blades	4X42-SSS
6" X 36" Standard Style Blades	6X36-SSS
6" X 42" Standard Style Blades	6X42-SSS
8" X 36" Standard Style Blades	8X36-SSS
8" X 42" Standard Style Blades	8X42-SSS
10" X 36" Standard Style Blades	10X36-SSS
10" X 42" Standard Style Blades	10X42-SSS





## LITTLE BEAVER PENGU SERIES AUGERS

DESCRIPTION	CODE
6" X 36" Pengo Style Blades	6X36-SSP
6" X 42" Pengo Style Blades	6X42-SSP
8" X 36" Pengo Style Blades	8X36-SSP
8" X 42" Pengo Style Blades	8X42-SSP
10" X 36" Pengo Style Blades	10X36-SSP
10" X 42" Pengo Style Blades	10X42-SSP

See Page 92 for Pengo Blades



## FLEXIBLE SHAFT ASSEMBLY

DESCRIPTION	CODE
Replacement Part for Little Beaver Mechanical Earth Drills	3224



## REPLACEMENT BLADE

DESCRIPTION	SIZE	CODE
For Little Beaver Standard Series/Carbine options also available	4"	9023-4
	6"	9023-6
	8"	9023-8
	10"	9023-10



## PILOT BIT - STANDARD

DESCRIPTION	CODE
For Little Beaver Standard Series	9027

## CEMENT MIXERS

### MULTIQUIP CONCRETE MIXER

DESCRIPTION	CODE
Honda GX-340 12cf Poly	MC12PH

Professional Contractor Grade  
Includes Tow Hitch.



### MULTIQUIP CONCRETE MIXER

DESCRIPTION	CODE
Kohler 9.5HP CH395 9CF Poly	MC94PK

Professional Contractor Grade  
Includes Tow Hitch.



### MULTIQUIP CONCRETE MIXER

DESCRIPTION	CODE
Kohler 9.5HP CH395 9CF Steel	MC94SK
Kohler 9.5HP CH395 6CF Steel	MC645K

Professional Contractor Grade  
Includes Tow Hitch.



## HAND TOOLS



### ALL STEEL HEAVY DUTY WHEEL BARROW

TIRE TYPE	QTY	CODE
6 Cu.ft. with Pneumatic Tire	1	103 74
Solid Tire (Replacement)	1	103 60
Pneumatic Tire Innertube (Replacement)	1	103 61

Wheel barrow tray - 18 gauge  
Steel handles - 14 gauge  
Legs - 3/16" steel



### PERFECTION DIGGER CLAMSHELL

DESCRIPTION	POINT SPREAD	QTY PER BOX	CODE
48" Fiberglass Handle	7 1/4"	2	DG12FG
48" Hardwood Handle	7"	2	DG12



### LONESTAR DIGGER

DESCRIPTION	POINT SPREAD	QTY PER BOX	CODE
48" Steel Handle	6 1/4"	2	DG15



### STRUCTRON HERCULES

DESCRIPTION	POINT SPREAD	QTY PER BOX	CODE
48" Fiberglass Handle	6 1/4"	2	PD48
48" Hardwood Handle	6 1/4"	2	DG11



### ATLAS PATTERN POST HOLE DIGGER - Round Hardwood Handle

DESCRIPTION	POINT SPREAD	QTY PER BOX	CODE
15 Gauge Sharpened Blade/ Double Bolt Connection	5"	12	13556



### ATLAS PATTERN POST HOLE DIGGER - XL Round Steel Handles

DESCRIPTION	POINT SPREAD	QTY PER BOX	CODE
15 Gauge Sharpened Blade/ Double Bolt Connection	5"	12	13558



### ATLAS PATTERN POST HOLE DIGGER - Square Premium Handle

DESCRIPTION	POINT SPREAD	QTY PER BOX	CODE
15 Gauge Sharpened Blade/ Double Bolt Connection	5"	12	13560/DG100

## EXTRA HD CUSTOM DESIGN POST HOLE DIGGER

DESCRIPTION	POINT SPREAD	CODE
Custom Design	7 1/4"	GM11XHD



Thicker longer steel blades. Thicker handles.

## ROUND POINT SHOVEL FTSX

DESCRIPTION	QTY PER BOX	CODE
48" Fiberglass Handle	3	30067
48" Hardwood Handle	3	30069
30" Fiberglass D Handle	3	30079
30" Hardwood D Handle	3	30071



## SQUARE POINT SHOVEL

DESCRIPTION	QTY PER BOX	CODE
48" Hardwood Handle	3	SVLS31



## SQUARE POINT SHOVEL FTSX

DESCRIPTION	QTY PER BOX	CODE
48" Fiberglass Handle	3	30068
48" Hardwood Handle	3	30070
30" Fiberglass D Handle	3	30080
30" Hardwood D Handle	3	30072



## TRENCHING SHOVEL

DESCRIPTION	QTY PER BOX	CODE
5" Blade, Hardwood Handle	3	30115



## HEAVY DUTY EXCAQUICK (FENCING SHOVEL) - ALL METAL

SIZE INS	FINISH	QTY PER BOX	CODE
54"	Super Black	5	608 006 0



## GENERAL PURPOSE SCOOP

DESCRIPTION	QTY PER BOX	CODE
#2 Steel, D Handle, 28 1/2"	3	13470
ABS, D Handle, 31 1/4"	3	30356



## SHORT HANDLE - D STYLE MIXING SHOVEL

DESCRIPTION	QTY PER BOX	CODE
41" Tumbled and Laquered	3	01039



## SAWDUST SCOOP

DESCRIPTION	QTY PER BOX	CODE
#12 Polyhead, 27" Fiberglass Handle, Poly D-Grip	3	SVSDP12





### STEEL LEAF RAKE WITH 24 CONTINUOUS TINES

DESCRIPTION	QTY PER BOX	CODE
54" Fiberglass Handle with Grip	3	30630
48" Premium Hardwood Handle	3	30640



### FORGED BOW RAKE WITH 16 TINES

DESCRIPTION	QTY PER BOX	CODE
60" Fiberglass Handle	3	30500
60" Premium Hardwood Handle	3	30501



### ROUGH BRISTLE STREET/LANDSCAPE BROOM

DESCRIPTION	QTY PER BOX	CODE
18" Extra HD Structron	4	82118
24" Fiberglass Handle	4	82018 / SB24R



### REPLACEMENT HANDLES

DESCRIPTION	QTY PER BOX	CODE
For Post Hole Digger, Round 44" Prem. Hardwood	1	13025
For Post Hole Digger, Square 44" Prem. Hardwood	1	13026
For Clamshell Digger, 48" Premium Hardwood	1	01038
For Post Hole Digger, Square 44" Fiberglass	1	13028
For Post Hole Digger, Square 44" Premium Steel	1	13027



### EXTRA HEAVY DUTY DIGGING BARS (ROCK BARS)

DESCRIPTION	COLOR	SHANK	QTY	CODE
70" - 18 lbs	Black	1 1/8"	1	DG2870
70" - 18 lbs, XL Chisel	Black	1 1/8"	1	DG2870XL
70" - 23 lbs	Black	1 1/8"	1	DG3270
70" - 23 lbs, XL Chisel	Black	1 1/8"	1	DG3270XL
80" - 21 lbs	Black	1 1/4"	1	DG2880
80" - 21 lbs, XL Chisel	Black	1 1/4"	1	DG2880XL
80" - 27 lbs	Black	1 1/4"	1	DG3280
80" - 27 lbs, XL Chisel	Black	1 1/4"	1	DG3280XL

Diamond and chisel point.



### TAMPING BAR

DESCRIPTION	SHANK	QTY	CODE
70" - 16.5lbs	1"	3	30973
72" - 17 lbs	1"	1	DG19/85366

Tamper and chisel heads.

SAN ANGELO BAR HEX		
DESCRIPTION	QTY PER BOX	CODE
72" - 17 lbs / 1" shank	3	DG23/30972

Diamond and chisel point.



WRECKING BAR		
DESCRIPTION	QTY PER BOX	CODE
1/2" Hexagonal Section, 1.25 lbs	3	10145
5/8" Hexagonal Section, 2.25 lbs	3	10146
3/4" Hexagonal Section, 3.25 lbs	3	10147
3/4" Hexagonal Section, 4.25 lbs	3	10148
3/4" Hexagonal Section, 5.25 lbs	3	10149



TAMPER		
DESCRIPTION	QTY PER BOX	CODE
Steel Handle with Grip	2	30982



FENCE PLIERS		
DESCRIPTION	QTY PER BOX	CODE
10" Round Nose Head, Forged Steel, Vinyl Grip	6	2T-120
10" Square Nose Head, Forged Steel, Vinyl Grip	6	2T-110



MALCO FENCE PLIERS		
DESCRIPTION	QTY PER BOX	CODE
8" Handle	5	FP1
10" Handle	5	FP2



MALCO VINYL FENCE NOTCHER		
DESCRIPTION	QTY PER BOX	CODE
3/4" Notch	5	VFN2



SHARPSHOOTER SHOVEL		
DESCRIPTION	QTY PER BOX	CODE
Standard Tip	1/12	MCS78B
With Dig Bar Tip	1/12	MC578D8



All metal with insulated handle.





# CONSTRUCTION SUPPLIES

Featuring construction supplies including saw blades and bonded abrasives, gloves, paint, extension cords, etc...



## MORE SIZES AVAILABLE ON ALL SAW BLADES & BONDED ABRASIVES



### DIABLO SAW BLADES

DESCRIPTION	QTY PER BOX	CODE
6 1/2" x 24-Tooth Framing Saw Blade	10/50	D0624A
7 1/4" x 24 Tooth Framing Saw Blade	10/50	D0724A
7 1/4" x 40 Tooth Finish Saw Blade	10/50	D0740A
10" x 60 Tooth Fine Finish Saw Blade	1	D1060X
10 1/4" x 40 x DIAM ATB (BIGFOOT)	1	D1040W
12" x 60 Tooth Combination Saw Blade	1	D1260X
12" x 96 Tooth Laminate/Aluminum Saw Blade	1	D1296L



### METAL GRINDING DISC

DESCRIPTION	QTY PER BOX	CODE
4-1/2" Metal Grinding Disc, Type 27	10/50	DBD045250701F



### METAL CUT-OFF DISC

DESCRIPTION	QTY PER BOX	CODE
5" Metal Cut Off Disc, Thin Kerf	10	DBD050040101F
6" Metal Cut Off Disc, Thin Kerf	10	DBD060045101F
4 1/2" Steel Demon Metal Cut-Off Disc, Type 1	25/100	DBDS45045101F
4 1/2" Steel Demon Metal Cut-Off Disc, Type 27	10/50	DBDS45045701F



### STEEL DEMON FLAP DISC

DESCRIPTION	QTY PER BOX	CODE
4-1/2" Steel Demon Flap Disc 40 Grit, Type 29	5/25	DCX045040N01F
4-1/2" Steel Demon Flap Disc 60 Grit, Type 29	5/25	DCX045060N01F
4-1/2" Steel Demon Flap Disc 80 Grit, Type 29	5/25	DCX045080N01F



### FLEAM GROUND RECIP BLADE FOR PRUNING

DESCRIPTION	QTY PER BOX	CODE
9" Fleam Ground Recip Blade for Pruning	5/25	DS0905FG5



### BI-METAL RECIP BLADE FOR NAIL EMBEDDED WOOD

DESCRIPTION	QTY PER BOX	CODE
6" Bi-Metal Recip Blade for Nail Embedded Wood	200	DS0612BW200
9" Bi-Metal Recip Blade for Nail Embedded Wood	200	DS0912BW200
9" Bi-Metal Recip Blade for Nail Embedded Wood	25	DS0912BW25

# CONSTRUCTION SUPPLIES

## BI-METAL RECIP BLADE FOR METAL CUTTING

DESCRIPTION	QTY PER BOX	CODE
6" Bi-Metal Recip Blade for Auto Dismantling	200	DS0614WBF200
6" Bi-Metal Recip Blade for Auto Dismantling	25	DS0614WBF25
9" Bi-Metal Recip Blade for Auto Dismantling	200	DS0914WBF200
9" Bi-Metal Recip Blade for Auto Dismantling	25	DS0914WBF25
9" 1/16 - 5/16 Medium Metal Cutting	25	DS0914BF25
9" 3/16 - 9/16 Thick Metal Cutting	25	D50908BF025



## LENOX WOLF-BAND PORTABLE BAND SAW BLADES

SIZE	TYPE	QTY PER BOX	CODE
35 3/8" COMPACT	10/14 TPI	5/25	1786673
35 3/8" COMPACT	14 TPI	5/25	1786674
35 3/8" COMPACT	18 TPI	5/25	1786675
44 7/8"	10/14 TPI	5/25	8009838PW10145
44 7/8"	14 TPI	5/25	8010738PW145
44 7/8"	14/18 TPI	5/25	8009938PW14185
44 7/8"	18 TPI	5/25	8010838PW185
44 7/8"	24 TPI	5/25	8010938PW245



## DEWALT PORTABLE BAND SAW BLADES

DESCRIPTION	LENGTH	QTY PER BOX	CODE
27" COMPACT	18 TPI	3/30	DWAPB27183



## PRO POWER TRIP TAP ADAPTER

SIZE	COLOR	QTY PER BOX	CODE
2'	Yellow	4	GM10612002



# CONSTRUCTION SUPPLIES



## ATLAS™ WORK GLOVES - NITRILE (SYNTHETIC COATED)

SIZE	COLOR	PRS PER BOX	CODE
Small	Blue Latex	12/144	510 300
Medium	Blue Latex	12/144	510 301
Large	Blue Latex	12/144	510 302
X-Large	Blue Latex	12/144	510 303
Small	Gray Thermal	12/144	510 451
Medium	Gray Thermal	12/144	510 456
Large	Gray Thermal	12/144	510 457
X-Large	Gray Thermal	12/144	510 458



## SHOWA EMBOSSED FOAM NITRILE GRIP GLOVES

SIZE	COLOR	PRS PER BOX	CODE
Medium	Gray/Black	12/144	511 346
Large	Gray/Black	12/144	511 347
Extra Large	Gray/Black	12/144	511 348 XL

High abrasion resistance level 4.



## PRO STYLE #12 SJTW 3COND LIGHTED EXTENSION CORD

SIZE	COLOR	QTY PER BOX	CODE	
25'	Green	8	GM19914025	
50'	Green	6	GM19914050	
100'	Green	4	GM19914100	
25'	Blue	8	GM19916025	
50'	Blue	6	GM19916050	
100'	Blue	4	GM19916100	
25'	Yellow	8	GM19918025	NEW COLOR
50'	Yellow	6	GM19918050	NEW COLOR
100'	Yellow	4	GM19918100	NEW COLOR

Soft drawn, bunch stranded 100% copper conductors. Clear Lighted connector indicating that there is power. Manufactured with cold weather jacketing and conductor compound.



## TOOL OIL

SIZE	QTY PER BOX	CODE
4 oz.	12	GMGRTO4OZ

# CONSTRUCTION SUPPLIES

## HEAVY DUTY STRAPPING BANDING WIRE

DESCRIPTION	LENGTH	TENSILE	QTY PER BOX	CODE
5/8" Steel x .020	2242'	1855 lbs	1	177 021

Other sizes available.



## WAXED SMOOTH POLYESTER STRAPPING

DESCRIPTION	LENGTH	TENSILE	QTY PER BOX	CODE
1/2" Poly x .026	7200'	450 lbs	1	178 060
5/8" Green x .035	4000'	1400 lbs	1	173081

Used for heavy-duty bundling



## SNAP SEALS

DESCRIPTION	QTY PER BOX	CODE
For 1/2" Plastic Strap	1000	175065
For 5/8" Plastic Strap	1000	175085
For 5/8" Steel Strap	2500	175036



## STRAP TENSIONER

DESCRIPTION	QTY PER BOX	CODE
For 3/8 to 3/4" Plastic	1	176010
For 3/8" to 3/4" Steel	1	176612



## STEEL STRAP HEAVY DUTY SEALER CRIMPER

DESCRIPTION	QTY PER BOX	CODE
For use with open or closed seals	1	176734



## STRAPPING CARTS

DESCRIPTION	QTY PER BOX	CODE
Fits Core Size 8"/16"	1	176725



# CONSTRUCTION SUPPLIES



## AIR HOSE WITH COUPLING

LENGTH FT	QTY PER BOX	CODE
50'	1	GMPU1450C
100'	1	GMPU14100C



## #18 TWINE

DESCRIPTION	COLOR	QTY PER BOX	CODE
275' Braided	Pink	12	134135
275' Twisted	Yellow	12	135 061
550' Braided	Pink	12	134 137
1100' Twisted	Yellow	12	135 141



## MINI COIL TRUCK ROPE

SIZE	COLOR	QTY PER BOX	CODE
1/2" x 50 ft	Orange & Black	1	152 025
1/2" x 100 ft	Orange & Black	1	152 030



## ALUMINUM FLASHING - 50' REEL

SIZE	QTY PER BOX	CODE
4"	5/10	604 006 9



## POLYETHYLENE WARNING FLAGS

COLOR	QTY PER ROLL	QTY PER BOX	CODE
Bright Red	1000	1	THF 1
Bright Red	250	1	THF 2

# CONSTRUCTION SUPPLIES

## TOUCH UP PAINT

DESCRIPTION	SIZE	QTY PER BOX	CODE
Black Touch Up Paint with Brush	1 oz.	5	650 000 3
White Touch Up Paint with Brush	1 oz.	5	650 000 0



Custom made to match all our black finish hardware.

## GROUND MARKING PAINT

DESCRIPTION	NET WT	SIZE	QTY PER BOX	CODE
Fluorescent Orange	17 oz	20 oz	12	650 024 7
Fluorescent Green	17 oz	20 oz	12	650 024 8
Pink	17 oz	20 oz	12	650 024 9
Fluorescent Blue	17 oz	20 oz	12	650 025 0
White	17 oz	20 oz	12	650 025 5
Hi-Vis Yellow	17 oz	20 oz	12	650 025 8



Construction MP lasts up to 3 months – for the jobsite where marks don't need to last as long. Great color retention throughout the mark's lifespan. Non-clogging tips. 16 colors available.

## ZYNOLYTE® MULTI-PURPOSE PRIMERS

DESCRIPTION	NET WT	SIZE	QTY PER BOX	CODE
Black	11 oz	16 oz	12	650 807 8
Red Oxide	11 oz	16 oz	12	650 807 4
Gray	11 oz	16 oz	12	650 807 2



Seals substrate. Fills in grain and surface imperfections. Fast drying and can be sanded. Adheres well to bare metal.

## ZINC RICH AEROSOLS

DESCRIPTION	SIZE	QTY PER BOX	CODE	
Cold Galv. Coating 93% Zinc Rich	Net 13 oz	12	650 700 7	PREMIUM GRADE
Bright Galv. Coating 65% Zinc Rich	Net 13 oz	12	650 700 8	
MRO Cold Galv. Coating	Net 13 oz	12	650 147	
MRO Bright Galv. Coating	Net 13 oz	12	650 148	



Available in matte gray or bright finish.  
7007 provides optimum corrosion protection with 93% zinc in the dry film.  
7008 provides excellent corrosion protection and a bright finish with 65% zinc in the dry film.  
Repair previously galvanized surfaces or add additional protection to bare metals.  
Also available in quarts and gallons in 6507007 and 6507008.

# CONSTRUCTION SUPPLIES



## SPEED E-NAMEL AEROSOL (MID GRADE)

DESCRIPTION	NET WT	SIZE	QTY PER BOX	CODE
Black Gloss	11 oz	16 oz	12	650 238 7
Black Semi-Gloss	11 oz	16 oz	12	650 227 7
Flat Black	11 oz	16 oz	12	650 248 7
Aluminum	11 oz	16 oz	12	650 231 7
Light Gray	11 oz	16 oz	12	650 248 9
Medium Gray	11 oz	16 oz	12	650 246 8
Silver	11 oz	16 oz	12	650 230 8
White Gloss	11 oz	16 oz	12	650 239 7
White Semi-Gloss	11 oz	16 oz	12	650 227 5
Flat White	11 oz	16 oz	12	650 237 7
Royal Blue	11 oz	16 oz	12	650 247 1
Hunter Green	11 oz	16 oz	12	650 246 9

Quick drying and durable finish. Use over metal, wood, or plastic. Primer recommended.



See page I07 for Marking Paint.

## RUST PROOF ANY-WAY SPRAY PAINT

DESCRIPTION	NET QT	SIZE	QTY PER BOX	CODE
Safety Black Gloss	12 oz	16 oz	12	6500306
Safety Silver	12 oz	16 oz	12	6500310
Flat Black	12 oz	16 oz	12	6500312
Satin Black	12 oz	16 oz	12	6500344

High-quality industrial enamel coating provides lasting protection. Adheres to any surface. High hide coverage. Primer not required but recommended over bare steel.





# FENCE STAIN

Stain designed for long - lasting, beautiful protection using fewer toxins.



		STAIN & SEAL			
		FINISH	COLOR	SIZES	CODE
	<b>CEDAR</b>	Transparent	Cedar	1 gallon	102-1
	Transparent			5 gallon	102-5
	<b>NATURAL</b>	Transparent	Natural	1 gallon	104-1
	Transparent			5 gallon	104-5
	<b>PECAN</b>	Semi - Transparent	Pecan	1 gallon	200-1
	Semi-Transparent			5 gallon	200-5
	<b>MAHOGANY</b>	Semi - Transparent	Mahogany	1 gallon	201-1
	Semi-Transparent			5 gallon	201-5
	<b>SEQUOIA</b>	Semi - Transparent	Sequoia	1 gallon	202-1
	Semi-Transparent			5 gallon	202-5
	<b>CHESTNUT</b>	Semi - Transparent	Chestnut	1 gallon	203-1
	Semi-Transparent			5 gallon	203-5
	<b>WALNUT</b>	Semi - Transparent	Walnut	1 gallon	204-1
	Semi-Transparent			5 gallon	204-5
	<b>BLACK</b>	Semi-Solid	Black	1 gallon	308-1
	Semi-Solid			5 gallon	308-5
	<b>SLATE GREY</b>	Semi-Solid	Slate Gray	1 gallon	305-1
	Semi-Solid			5 gallon	305-5

These colors are for reference only and may not exactly match the final stain. We recommend testing the product on a small, inconspicuous area before applying it to the entire project.

## CLEAN & BRIGHT (POWDER)

DESCRIPTION	FINISH	SIZES	CODE
A biodegradable, surface-safe cleaner designed to lift dirt, grime, and organic buildup without harsh residue. Eco-Cleaner prepares exterior wood gently yet effectively, restoring clarity while supporting responsible maintenance.	ECO-CLEANER	8 oz	501-8
		32 oz	501-32
		1 gal	501-1
		5 gal	501-5
A powerful exterior wood cleaner formulated to remove deep-set grime, mildew, and environmental staining. This concentrated solution penetrates surface buildup to prepare wood properly for staining or refinishing.	WOOD CLEANER	8 oz	502-8
		32 oz	502-32
		1 gal	502-1
		5 gal	502-5
A professional-grade brightener that restores wood's natural tone and neutralizes cleaner residue. Wood Brightener enhances grain definition while preparing the surface for optimal stain absorption and uniform finish results.	WOOD BRIGHTNER	8 oz	503-8
		32 oz	503-32
		1 gal	503-1
		5 gal	503-5



## CLEAN & BRIGHT

DESCRIPTION	FINISH	SIZES	CODE
A dependable cleanup solution designed to simplify post-project maintenance and equipment care. Clean Up helps remove product residue from tools and surfaces, supporting efficiency and a polished final result.	CLEAN UP DEGREASER (LIQUID Concentrate)	1 gal	506-1
		5 gal	506-5



## INSECT DEFENSE

DESCRIPTION	FINISH	SIZES	CODE
A plant-based additive designed to enhance exterior wood protection with essential oil technology. Natural Defense helps deter wood-boring insects while supporting a more naturally resilient finish. Can be added to stain.	Natural Defense (Citronella Additive)	8 oz	700-08





2500

**ABBEY**  
HARDWARE

WILLSCOOT

**ABBEY**  
FENCEPRO

**ABBEY**  
GATEPRO

**ABBEY**  
HARDWARE  
**SECURITY MADE EASY**  
No Batteries. No electricity. Easy install.  
Made in the UK.



**ABBEY**  
HARDWARE

**ABBEY**  
GATEPRO

ware.com  
byfencepro.com

**FENCES & DECKS**  
Quality Projects...affordable prices



# AG FENCING / **WELDED WIRE**

High quality welded wire in 12.5, 14 and 16 gauge. Comes in HDG or powder coated black, green and brown.



# AG FENCING / WELDED WIRE

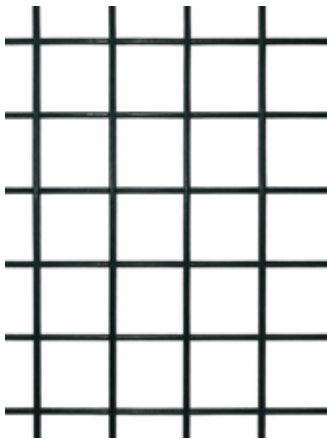

HD WELDED WIRE			
DESCRIPTION	GAUGE	ROLLS/PALLET	CODE
1 1/2" x 4" x 48" x 100'	12.5	9	W48411212100
1 1/2" x 4" x 48" x 100'	14	9	W48411214100
1 1/2" x 4" x 48" x 100'	16	9	W48411216100
1 1/2" x 4" x 60" x 100'	14	9	W60411214100
1" x 1" x 60" x 100'	16	9	W6011116100
1" x 1" x 48" x 100'	14	9	W4811114100
1" x 1" x 48" x 100'	16	9	W4811116100
1" x 1" x 72" x 100'	14	9	W7211114100
2" x 2" x 48" x 100'	14	9	W482214100
2" x 2" x 60" x 100'	14	9	W602214100
2" x 2" x 72" x 100'	14	9	W722214100
2' x 4" x 72" x 100'	14	9	W724214100
2" x 4" 60" x 100'	14	9	W604214100
2" X 4" X 48" x 50'	14	16	W48421450
2" x 4" x 48" x 100'	12.5	9	W484212100
2" X 4" X 36" X 100'	14	9	W364214100
2" X 4" X 48" x 100'	12.5	9	W484212100
2" x 4" x 48" x 100'	14	9	W484214100
2" x 4" x 48" x 100'	16	9	W484216100
2" x 4" x 60" x 50'	14	16	W60421450
2" x 4" x 60" x 100'	12.5	9	W604212100
2" x 4" x 72" x 50'	12.5	16	W72421250
2" x 4" x 72" x 100'	14	9	W724214100
2" x 4" x 72" x 100'	12.5	9	W724212100

Codes listed are for HDG. For Black Coating add /B, Green /G, Brown /BR to end of code.



T-POSTS		
DESCRIPTION	QTY PER PALLET	CODE
8' 1.25LB/FT	100	TP80125GC
7' 1.25LB/FT	100	TP70125GC

For use with welded wire.

# AG FENCING / WELDED WIRE

## Z-POSTS FOR USE WITH WOOD

DESCRIPTION	QTY PER PALLET	CODE
84" Heavy 10 Gauge Galv. Steel	100	ZPOST7
90" Heavy 10 Gauge Galv. Steel	100	ZPOST76
96" Heavy 10 Gauge Galv. Steel	100	ZPOST8
108" Heavy 10 Gauge Galv. Steel	100	ZPOST9
120" Heavy 10 Gauge Galv. Steel	100	ZPOST10
124" Heavy 10 Gauge Galv. Steel	100	ZPOST12



- 1 type of Metal posts for line posts, corner posts and gate posts
- No hardware or brackets needed
- Designed for easy installation of kick boards, top caps, lattice work & more
- Designed for use with standard size lumber
- Top to bottom staggered hole pattern allows for easy installation, better holding strength and reducing the possibility of splitting
- Can also easily be concealed by placing a 6" board over the post
- Withstand wind gusts of up to 73 miles an hour
- Hole patterns make installation easy The Z/Post works as a natural gate stop

## FIELD FENCE 12.5 GAUGE

SIZE	COATING	FINISH	CODE
39" X 330'	Class 1	GALV	FF6655
47" X 330'	Class 1	GALV	FF6656
58" X 165'	Commercial	GALV	FF6748
71" X 165'	Commercial	GALV	FF6749

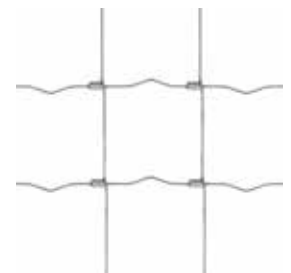

Graduated openings - smaller at bottom & larger at the top.  
Prevents small animals from getting through.

## HORSE FENCE, NON CLIMB, 2" X 4" - 12.5 GAUGE

SIZE	COATING	FINISH	CODE
2" X 4" X 60" X 100'	Class 1	GALV	HF6793
2" X 4" X 72" X 100'	Class 1	GALV	HF6794
2" X 4" X 48" X 100"	Class 1	GALV	HF6795
2" X 4" X 48" X 200'	Class 1	GALV	HF6955
2" X 4" X 60" X 200'	Class 1	GALV	HF6956
2" X 4" X 72" X 100'		BLACK	7787

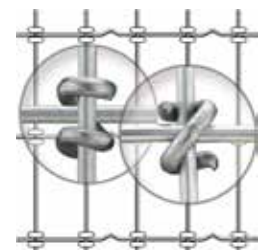

# AG FENCING / WELDED WIRE



## RAILING PANELS 6 GAUGE

SIZE	FINISH	CODE
36" X 6' - 4" X 4"	HDG	RP36440606
36" X 6' - 4" X 4"	BLACK	RP36440606/B
36" X 8' - 4" X 4"	HDG	RP36440608
36" X 8' - 4" X 4"	BLACK	RP36440608/B
48" X 8' - 4" X 4"	HDG	RP48440608
48" X 8' - 4" X 4"	BLACK	RP48440608/B
60" X 6' - 4" X 4"	HDG	RP60440606
60" X 6' - 4" X 4"	BLACK	RP60440606/B
60" X 8' - 4" X 4"	HDG	RP60440608
60" X 8' - 4" X 4"	GALV	RP60440608/B
72" X 8' - 4" X 4"	HDG	RP72440608
72" X 8' - 4" X 4"	GALV	RP72440608/B
84" X 8' - 4" X 4"	HDG	RP84440608
84" X 8' - 4" X 4"	BLACK	RP84440608/B





# HUGE IN STOCK INVENTORY SPECIFICALLY FOR THE FENCING INDUSTRY.







# TERMS AND CONDITIONS

## SHIPPING

Orders are usually shipped within 1–3 days of receipt of order (delay in payment may delay shipping). Free freight is available on qualifying minimum orders. This minimum may change from time to time; please contact a representative for current requirements. No free freight on drop ship orders.

## TERMS OF PAYMENT

Net 10 or 20 days, with approved credit. Customers wishing to establish a line of credit must complete the business credit application furnished by Abbey Hardware. If Abbey Hardware is unable to establish credit, full payment must be received before any orders can be processed.

Payment may be made via check, money order, ACH, COD, or Visa/Mastercard. If any action is brought to enforce collection, the prevailing party shall be entitled to recover its reasonable attorneys' fees and costs. Venue for any such action shall be in the Superior Court of the State of California, County of Alameda.

Until Abbey Hardware has received payment in full, Abbey Hardware retains title to each product sold. Invoices are due immediately upon customer's receipt of the products. Unpaid invoices shall accrue interest at 2% per month from the due date.

## RETURN POLICY

Upon proof that the product was purchased from Abbey Hardware, and subject to the terms of the Limited Warranty, Abbey Hardware will replace all defective products free of charge if the item is available. Otherwise, a full credit will be issued.

The RGA number shall be the same as the invoice number under which the product was purchased. This must be written on the box or included with the return documentation.

All other returned goods are subject to a 20% restocking fee. Returns (including all parts and fasteners) are accepted within 60 days of purchase in new condition and original packaging and are subject to the restocking fee.

## INVOICE/ORDER DISCREPANCIES

Any invoice or order discrepancies must be reported within 30 days of the invoice date.

## ABBEY TRADING AND ABBEY HARDWARE ARE DBAs OF THE PROCTOR GROUP, LLC.

## PRODUCTS COVERED AND DURATION OF WARRANTY

This Limited Warranty from Abbey Hardware applies to all products manufactured or distributed by Abbey Hardware. The term "product" means an Abbey Hardware product.

The product purchased shall be free from defects in materials and workmanship for a period of one (1) year from the date of shipment by Abbey Hardware. For any third-party or non-Abbey Hardware branded products sold by Abbey Hardware, the applicable manufacturer's warranty shall apply and will supersede this Limited Warranty.

## TERMS OF THE WARRANTY

Abbey Hardware warrants that the product you have purchased is free from defects in materials and workmanship under normal use during the warranty period. The warranty period begins on the date of shipment from Abbey Hardware.

The warranty extends only to the original purchaser and is not transferable.

During the warranty period, Abbey Hardware will repair or replace defective parts with new parts or, at its option, serviceable used parts that are equivalent to new parts in performance.

This Limited Warranty extends only to products purchased from Abbey Hardware. This Limited Warranty does not extend to any product that has been damaged or rendered defective:

- (a) as a result of accident, misuse, or abuse;
- (b) as a result of an act of God;
- (c) by operation outside the usage parameters stated herein;
- (d) by the use of parts not manufactured or sold by Abbey Hardware;
- (e) by modification of the product; or
- (f) as a result of war or terrorist attack.

EXCEPT AS EXPRESSLY SET FORTH IN THIS WARRANTY, ABBEY HARDWARE MAKES NO OTHER WARRANTIES EXPRESS OR IMPLIED, INCLUDING ANY IMPLIED WARRANTIES OF MERCHANTABILITY AND FITNESS FOR A PARTICULAR PURPOSE. ABBEY HARDWARE EXPRESSLY DISCLAIMS ALL WARRANTIES NOT STATED IN THIS LIMITED WARRANTY. ANY IMPLIED WARRANTIES THAT MAY BE IMPOSED BY LAW ARE LIMITED TO THE TERMS OF THIS EXPRESS LIMITED WARRANTY.

This Limited Warranty shall be interpreted and governed by the laws of the State of California.

## DATA

Illustrations, weights, and measurements supplied by Abbey Hardware are statements of opinion and are provided for informational purposes only and form no part of the contract.



## FENCING SUPPLY EXPERTS



**GATE HARDWARE**



**WIRE FENCING**



**SECURITY LOCKS**



**CONSTRUCTION SUPPLIES**



**NAILS, STAPLES & SCREWS**



**TOOLS**



866-98-ABBEY  
sales@abbeyhardware.com  
www.abbeyhardware.com